

EGYPTIAN BOMB, 100-KG, INCENDIARY (THERMITE)

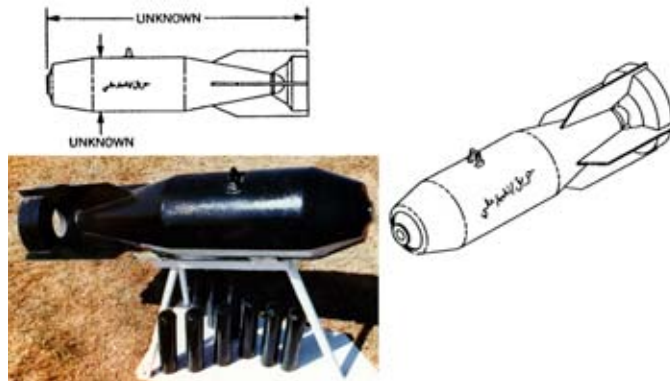

**FRENCH BOMB, 4-KG, PRACTICE, BAVARD TYPE
F3B**



SPANISH BOMB, 500-KG, GP, BNI-500



U.S.S.R. BOMB, CHEMICAL, KHAB-100



Ordnance used with:
AGM 1, BOMB, NOSE
AGM 3, BOMB, NOSE
AM-A, BOMB, NOSE
AM A B/V, BOMB, NOSE
AM B, BOMB, NOSE
AM B B/V, BOMB, NOSE
TM-4B, BOMB, NOSE, MT

U.S.S.R. BOMB, PARACHUTE DEPLOYMENT MECHANISM, KP-527

Ordnance used with:
AV-527, NOSE, ELECTRIC



U.S.S.R. BOMB, FRAG, AO-2.5-2

Ordnance used with:
AGM 3, BOMB, NOSE
AM B, BOMB, NOSE
AM B B/V, BOMB, NOSE
RBK-250-275, DISPENSER

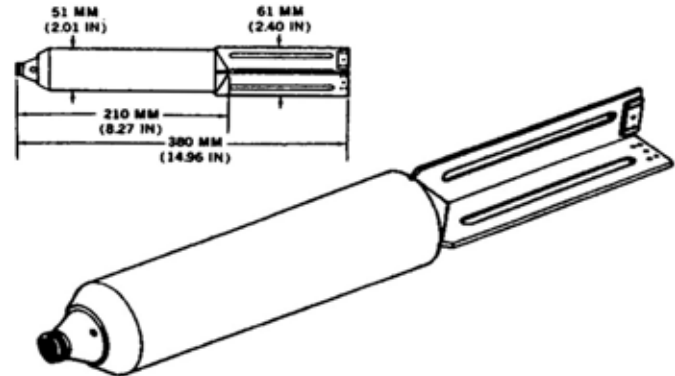

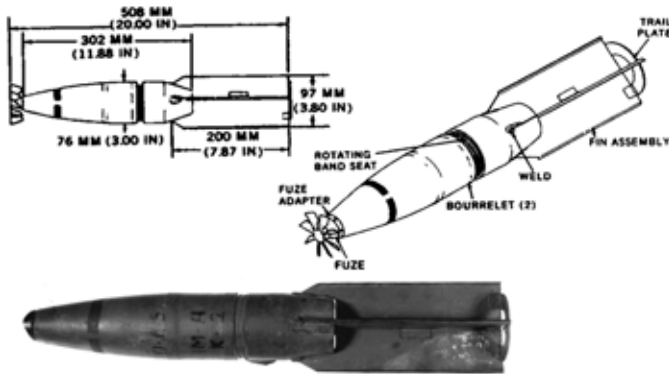

U.S.S.R. BOMB, FRAG, AO-10-6.5

Ordnance used with:
 AGM 1, BOMB, NOSE
 AGM 3, BOMB, NOSE
 AM-A, BOMB, NOSE
 AM A B/V, BOMB, NOSE
 AM B, BOMB, NOSE
 AM B B/V, BOMB, NOSE
 RBK-250, CLUSTER, ADAPTER
 N.E.W. 0.50 KG

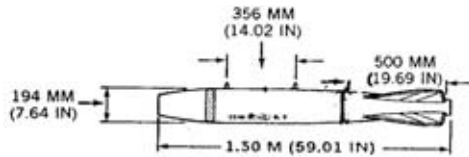

FRENCH BOMB, 125-KG, GP, BL9



FRENCH BOMB, 115-KG, LDGP, BL 7

Ordnance used with:
FEU 80 BC, IMPACT, TAIL
FEU 80 PRLF, PROXIMITY
FEU 80 BO, NOSE, IMPACT
M905E, TAIL, IMPACT
FEP 80, PROXIMITY
FEP 80 SF, PROXIMITY
FEP 80 BL, PROXIMITY

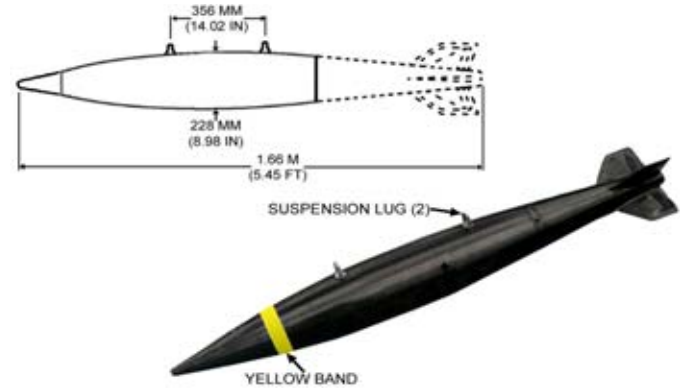

U.S.S.R. BOMB, CHEM, KRAB-25 YAD

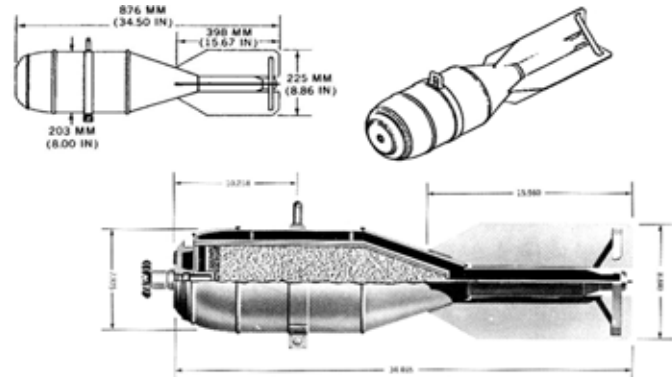

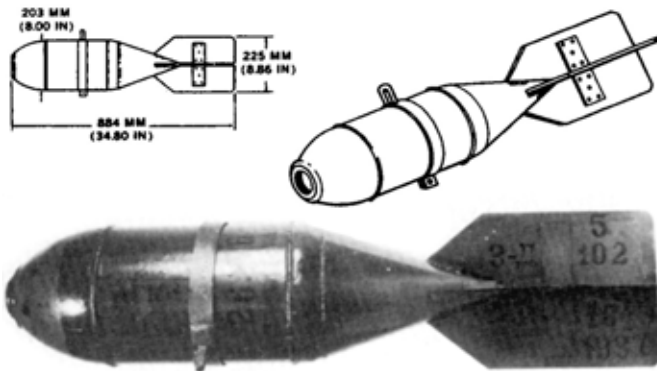

U.S.S.R. BOMB, CHEMICAL, KHAB-25

Ordnance used with:
 AGDT B, BOMB, NOSE
 AGM 1, BOMB, NOSE
 AGM 3, BOMB, NOSE
 AM-A, BOMB, NOSE
 AM A B/V, BOMB, NOSE
 AM B, BOMB, NOSE
 AM B B/V, BOMB, NOSE

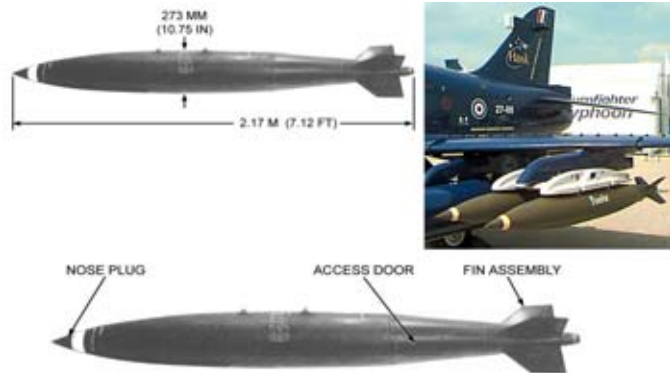

ITALIAN BOMB, 227-KG, GP, BA 102 (TYPE 2)

SPANISH BOMB, FRAG, BRFF-250

Ordnance used with:
GRL/AR, TRANSVERSE, LONG DELAY
MU 016, PROXIMITY
MU-5, BOMB, NOSE FUZE
MU05, BOMB, NOSE
MU 05, BOMB, NOSE, IMPACT
MU 09, BOMB, NOSE
MU 9, BOMB, NOSE

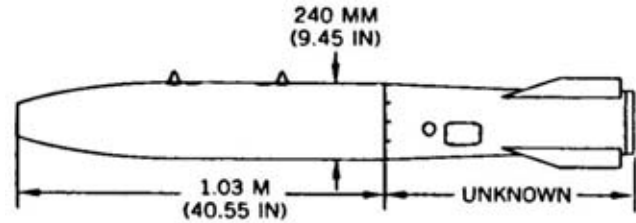

EGYPTIAN BOMB, 100-KG, APERS, KAAKAA-120

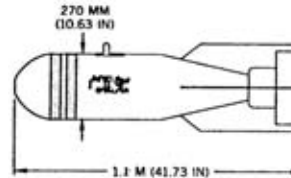

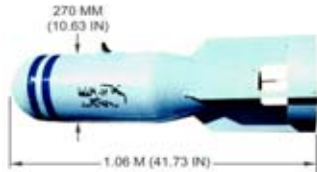

IRAQI BOMB, 100-KG, FRAG, KAAKAA-120

Ordnance used with:
UNKNOWN, BOMB NOSE, TYPE UNKNOWN

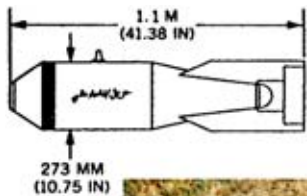

EGYPTIAN BOMB, 100-105 KG, INCENDIARY, KAAKAA-100-105

**IRAQI BOMB, 100-105 KG, INCENDIARY,
KAAKAA-100-105**

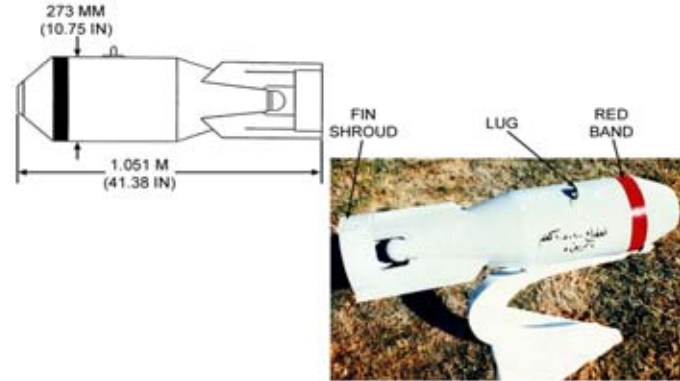

**U.S. BOMB UNITS, GUIDED, GBU-12B/B, GBU-12C/B,
AND GBU-12D/B**

Ordnance used with:

FMU-139/B, NOSE & TAIL, IMPACT

FMU-139A/B, NOSE & TAIL, IMPACT

FMU-26/B, BOMB FUZE, NOSE & TAIL, MULTIPURPOSE

FMU-26A/B, BOMB FUZE, NOSE & TAIL, MULTIPURPOSE

FMU-26B/B, BOMB FUZE, NOSE & TAIL, MULTIPURPOSE

FMU-81/B, BOMB FUZE, NOSE & TAIL, IMPACT, SHORT-DELAY

M905, TAIL, IMPACT

N.E.W. 88.00 KG

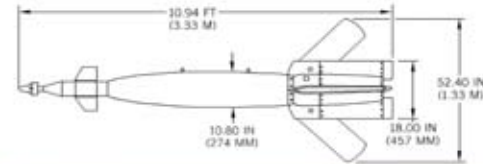

**U.S.S.R. BOMB, 100-KG, HE-FRAG, OFAB 100-120
(RETARDED)**

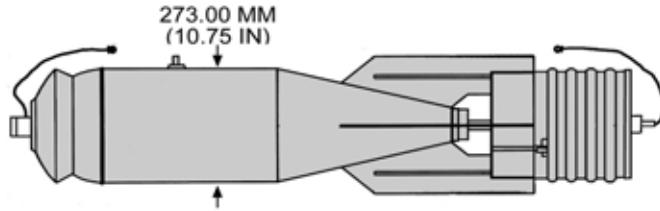

U.S.S.R. BOMB, FRAG, OFAB-100-120

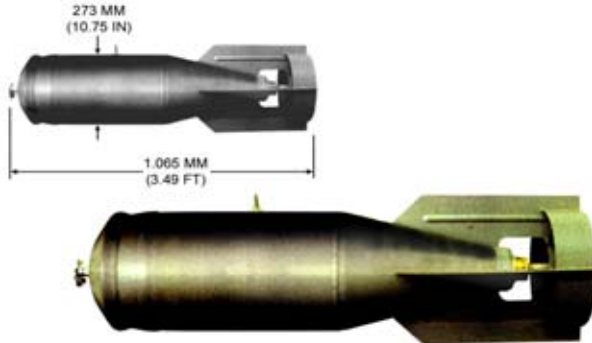

Ordnance used with:
AVU-ET, NOSE/TAIL, IMPACT
TU-100-120, PARACHUTE ASSEMBLY
AVU, BOMB, NOSE
JUPITER 2000, BOMB, TAIL, IMPACT/DELAY
AMV-AE2, FUZE, BOMB
AVU-ETM, BOMB FUZE

N.E.W. 46.00 KG

U.S. BOMB UNITS, GUIDED, GBU-12/B & GBU-12A/B

Ordnance used with:

FMU-139/B, NOSE & TAIL, IMPACT

FMU-139A/B, NOSE & TAIL, IMPACT

FMU-26/B, BOMB FUZE, NOSE & TAIL, MULTIPURPOSE

FMU-26A/B, BOMB FUZE, NOSE & TAIL, MULTIPURPOSE

FMU-26B/B, BOMB FUZE, NOSE & TAIL, MULTIPURPOSE

FMU-81/B, BOMB FUZE, NOSE & TAIL, IMPACT, SHORT-DELAY

M905, TAIL, IMPACT

N.E.W. 88.00 KG

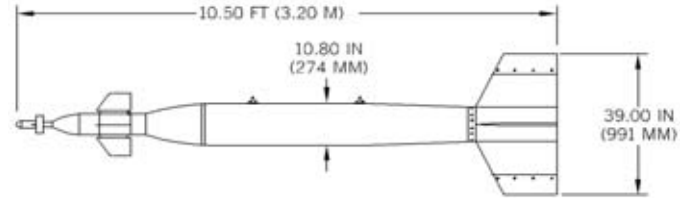

U.S. BOMB, 500-LB, GP (LOW DRAG), MK 82

Ordnance used with:

AN-M166, NOSE, PROXIMITY

BSU-49/B, FIN ASSEMBLY, AIR INFLATABLE RETARDER

BSU-86/B, FIN

DSU-30/B, BOMB TARGET DETECTING DEVICE

DSU-33A(D-2)/B, SENSING ELEMENT, DUMMY

DSU-33A/B, SENSING ELEMENT, PROXIMITY

FMU-112/B, BOMB FUZE, NOSE & TAIL

N.E.W. 87.10 KG

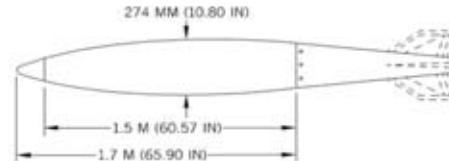

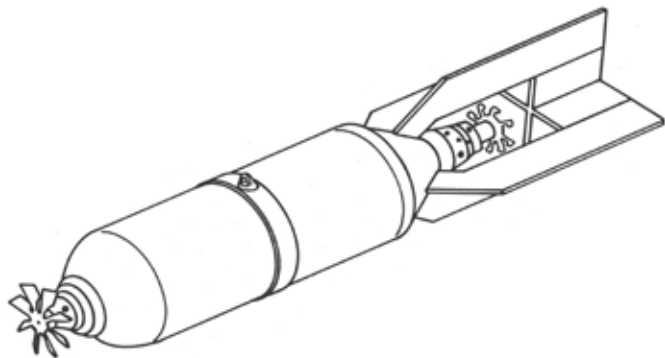

U.S.S.R. BOMB, PRACTICE, P-100

Ordnance used with:
AM-A, BOMB, NOSE
AM B, BOMB, NOSE
AM B B/V, BOMB, NOSE
TM-24B, BOMB, NOSE OR TAIL, MT



IRAQI BOMB, 250-KG, CHEMICAL, MODEL UNKNOWN

SPANISH BOMB, 250-KG, FRAG, SUPER RETARDED, BRFF-250

Ordnance used with:
INFARR, TAIL, DELAY
MU-017, NOSE, TIME, SHORT DELAY
EP-516, BOMB, NOSE, PROXIMITY
EROS, NOSE, IMPACT

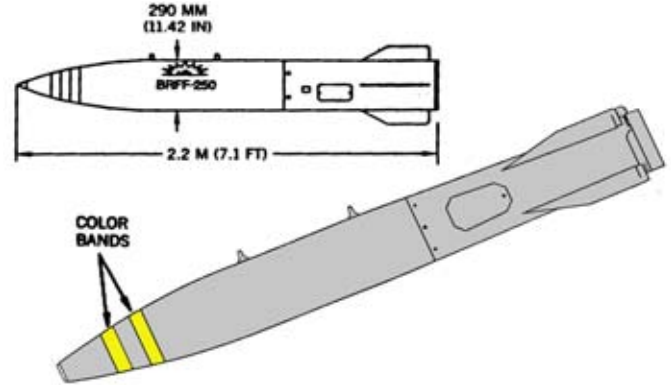

SPANISH BOMB, GP, MODEL BR-250

Ordnance used with:
EPB 1A, BOMB, NOSE, PROXIMITY
GRC-AR, BOMB, TAIL, LONG DELAY ANTIDISTURBANCE
MU 08, BOMB, TAIL
MU-8, BOMB, TAIL FUZE
GRC, LONG DELAY
MU-09, BOMB, NOSE FUZE
MU-9, BOMB, NOSE FUZE

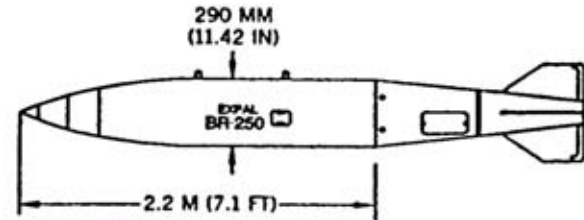



IRAQI BOMB, GP/FRAGMENTATION, MODEL UNKNOWN

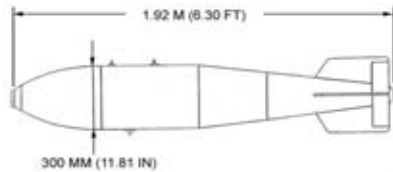

IRAQI BOMB, 250-KG, GENERAL PURPOSE, FARIS 250



U.S.S.R. BOMB, HE-FRAG, OFAB-250T

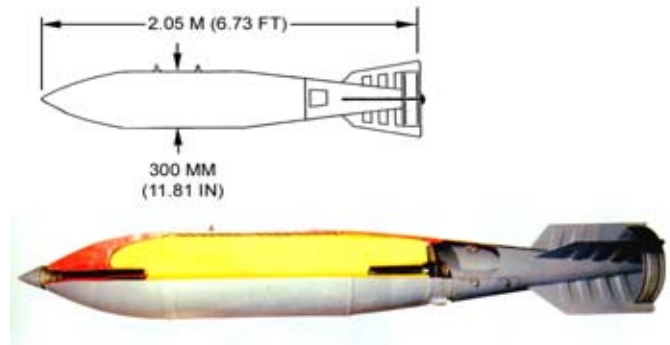

N.E.W. 95.70 KG

CHILEAN BOMB, FRAG, CFB 27



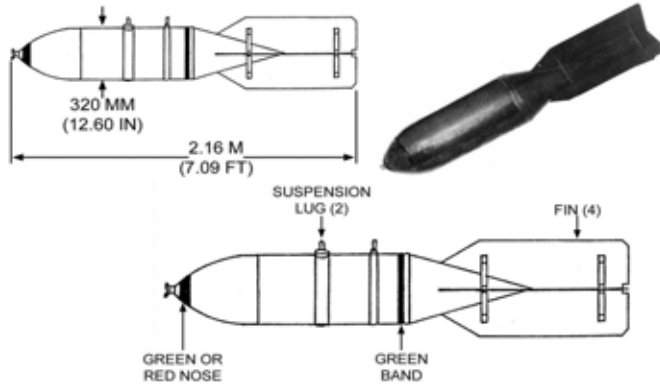

SOVIET BOMB, CHEMICAL, Khab-200 R-5 AND R-10

Ordnance used with:
 AGDT B, BOMB, NOSE
 AGM 1, BOMB, NOSE
 AGM 3, BOMB, NOSE
 AM-A, BOMB, NOSE
 AM A B/V, BOMB, NOSE
 AM B, BOMB, NOSE
 AM B B/V, BOMB, NOSE

N.E.W. 1.50 LB

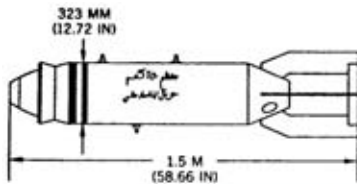

EGYPTIAN BOMB, 250-KG, HE-INCENDIARY, KAAKAA-250



N.E.W. 15.00 KG

**IRAQI BOMB, 250-KG, HE AND INCENDIARY,
KAAKAA-250**



EGYPTIAN BOMB, 250-KG, GP, NASR-250

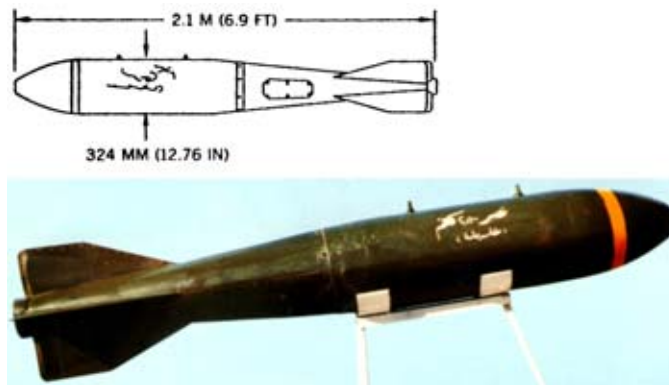

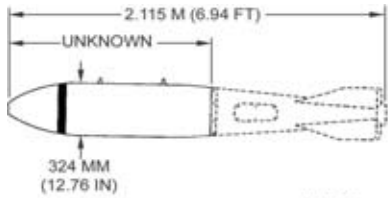

IRAQI BOMB, 250-KG, GP, NASR-250

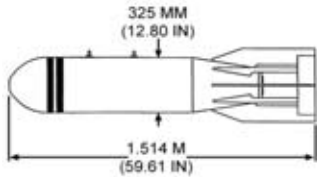

IRAQI BOMB, 250-KG, APERS, KAAKAA-250



U.S.S.R. BOMB, 250-KG, HE, FAB-250 M54

Ordnance used with:
APUV, NOSE AND TAIL
APUV-1, NOSE AND TAIL
APUVM, BOMB, NOSE AND TAIL
AV 1, NOSE AND TAIL
AV 1 MODIFIED, BOMB, NOSE AND TAIL
AV 1D/U, BOMB, NOSE AND TAIL
AVDM, TAIL

N.E.W. 96.40 KG

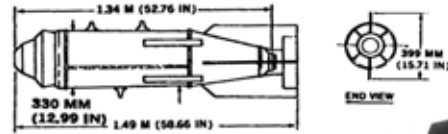

U.S.S.R. BOMB, FRAG, 250-KG, OFAB-250-270

Ordnance used with:
AM B, BOMB, NOSE
AM B B/V, BOMB, NOSE
APUV-1, NOSE AND TAIL
VDV, NOSE AND TAIL
VDV-1, NOSE AND TAIL
VDV 2, BOMB, NOSE AND TAIL
AVU, BOMB, NOSE

N.E.W. 94.00 KG

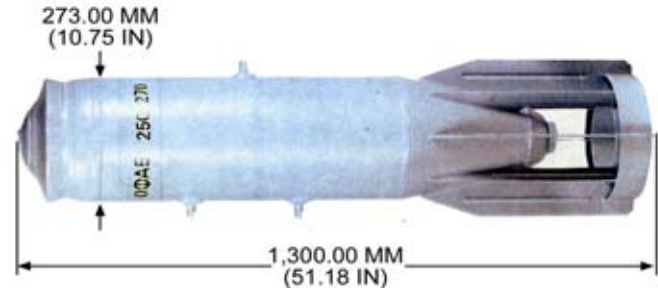

**U.S.S.R. BOMB, HE-FRAG, 250-KG, OFAB-250SHL
(RETARDED)**

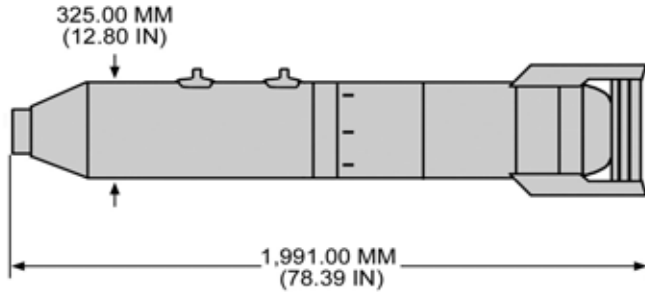

N.E.W. 92.00 KG

U.S.S.R. BOMB, INCENDIARY, ZAB 250-200

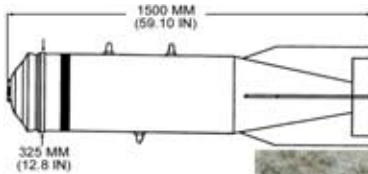

U.S.S.R. BOMB, HE-FRAG, 250-KG, OFAB-250SH



IRAQI BOMB, 500-KG, PENETRATION, NASR-500P1

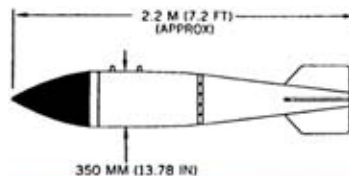

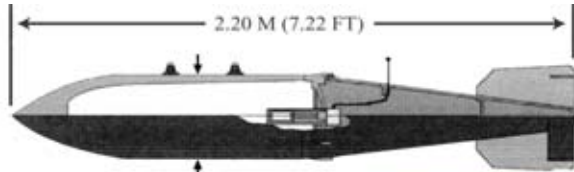

350 MM
(13.78 IN)



U.S.S.R. BOMB, 478-KG, TARGET PENETRATION, BETAB-500

N.E.W. 75.80 KG

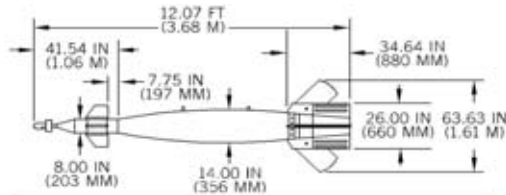

U.S. BOMB UNITS, GUIDED, GBU-16/B, GBU-16A/B, AND GBU-16B/B

Ordnance used with:

FMU-124A/B, NOSE & TAIL, IMPACT

FMU-139/B, NOSE & TAIL, IMPACT

FMU-139A/B, NOSE & TAIL, IMPACT

FMU-26/B, BOMB FUZE, NOSE & TAIL, MULTIPURPOSE

FMU-26A/B, BOMB FUZE, NOSE & TAIL, MULTIPURPOSE

FMU-26B/B, BOMB FUZE, NOSE & TAIL, MULTIPURPOSE

FMU-81/B, BOMB FUZE, NOSE & TAIL, IMPACT, SHORT-DELAY

N.E.W. 203.00 KG

U.S. BOMB, 1000-LB, GP (LOW DRAG), MK 83

Ordnance used with:

BSU-85/B, BOMB FIN ASSEMBLY, AIR INFLATABLE RETARDER

DSU-30/B, BOMB TARGET DETECTING DEVICE

DSU-33A(D-2)/B, SENSING ELEMENT, DUMMY

DSU-33A/B, SENSING ELEMENT, PROXIMITY

FMU-112/B, BOMB FUZE, NOSE & TAIL

FMU-113/B, PROXIMITY

FMU-124A/B, NOSE & TAIL, IMPACT

N.E.W. 202.00 KG

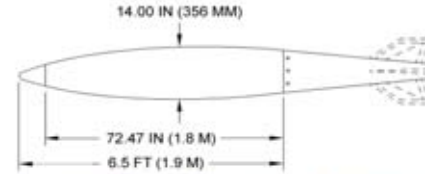

SPANISH BOMB, 224-KG, CHEMICAL, BR-500

N.E.W. 5.00 KG



SPANISH BOMB, 500-KG, AIRCRAFT- B.R. (LOW DRAG), (BR 500)

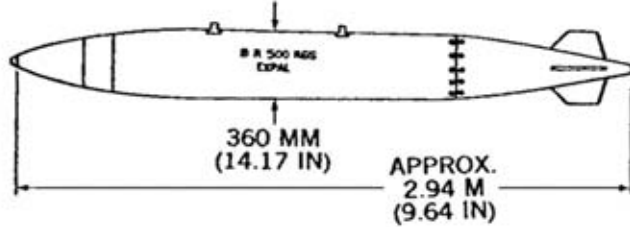

Ordnance used with:
 EPB 1A, BOMB, NOSE, PROXIMITY
 GRL/AR, TRANSVERSE, LONG DELAY
 GRL, BOMB FUZE LONG DELAY ANTI-REMOVAL



SPANISH BOMB, 500-KG, GP, RETARDED, BRP-500

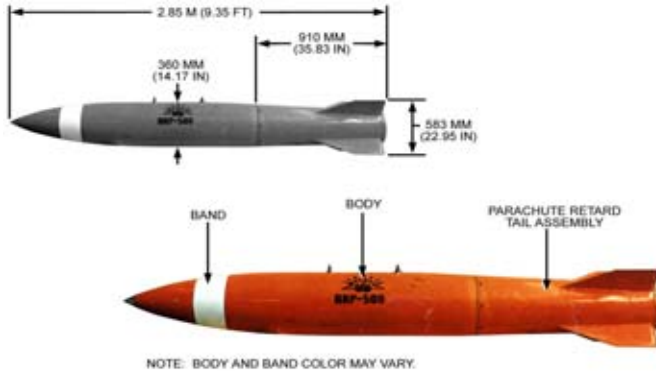

Ordnance used with:
 GAMA-R, BOMB, TRANSVERSE, IMPACT, ALL-WAY-ACTING
 GAMMA, BOMB, TRANSVERSE, IMPACT (ALL WAY ACTION)
 KAPPA 3, BOMB, NOSE, ALL WAY
 KAPPA III, BOMB, NOSE, ALL WAY
 KEMA III, NOSE, ELECTRIC CLOCKWORK
 GRL/AR, TRANSVERSE, LONG DELAY
 ECOS 08, TAIL, IMPACT (ALL-WAY ACTION)
 N.E.W. 210.00 KG

U.S. BOMB UNIT, GUIDED, GBU-15(V)2/B

Ordnance used with:

BLU-109/B, PENETRATOR

FMU-143/B, BOMB FUZE, NOSE & TAIL, IMPACT

FMU-143A/B, BOMB FUZE, NOSE & TAIL, IMPACT

FMU-143B/B, NOSE & TAIL, IMPACT

FMU-143D/B, BOMB FUZE, NOSE & TAIL, IMPACT

FMU-143E/B, NOSE & TAIL, IMPACT

FMU-143F/B, NOSE & TAIL, IMPACT

N.E.W. 244.00 KG

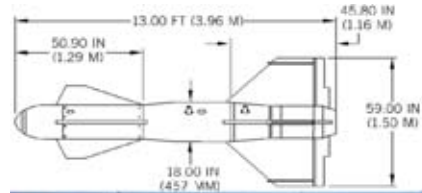

U.S. BOMB UNIT, GUIDED, GBU-15(V)32/B

Ordnance used with:

BLU-109/B, PENETRATOR

FMU-143/B, BOMB FUZE, NOSE & TAIL, IMPACT

FMU-143A/B, BOMB FUZE, NOSE & TAIL, IMPACT

FMU-143B/B, NOSE & TAIL, IMPACT

N.E.W. 244.00 KG

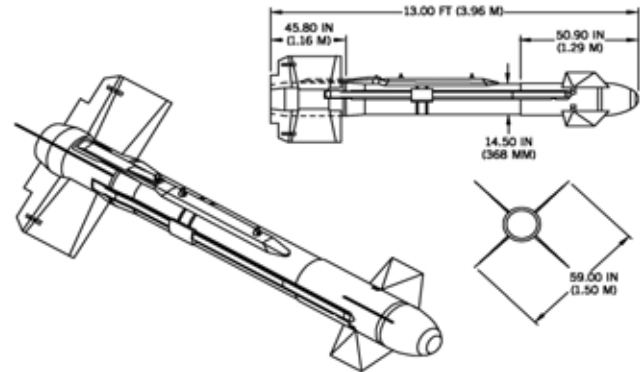

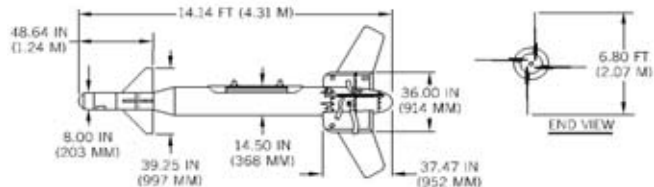

U.S. BOMB UNIT, GUIDED, GBU-24A/B

Ordnance used with:

BLU-109/B, PENETRATOR

FMU-143/B, BOMB FUZE, NOSE & TAIL, IMPACT

FMU-143A/B, BOMB FUZE, NOSE & TAIL, IMPACT

FMU-143B/B, NOSE & TAIL, IMPACT

FMU-143D/B, BOMB FUZE, NOSE & TAIL, IMPACT

FMU-143E/B, NOSE & TAIL, IMPACT

FMU-143F/B, NOSE & TAIL, IMPACT

N.E.W. 243.00 KG

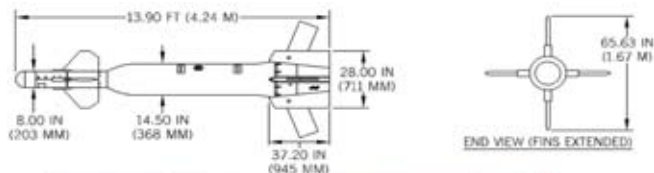

U.S. BOMB UNIT, GUIDED, GBU-27/B

Ordnance used with:

BLU-109/B, PENETRATOR

FMU-124A/B, NOSE & TAIL, IMPACT

FMU-139/B, NOSE & TAIL, IMPACT

FMU-139A/B, NOSE & TAIL, IMPACT

FMU-143/B, BOMB FUZE, NOSE & TAIL, IMPACT

FMU-143B/B, NOSE & TAIL, IMPACT

FMU-81/B, BOMB FUZE, NOSE & TAIL, IMPACT, SHORT-DELAY

N.E.W. 243.00 KG

U.S.S.R. BOMB, 500-KG, GP, FAB-500, M62

Ordnance used with:
VDV, NOSE AND TAIL
AVU, BOMB, NOSE

N.E.W. 213.00 KG

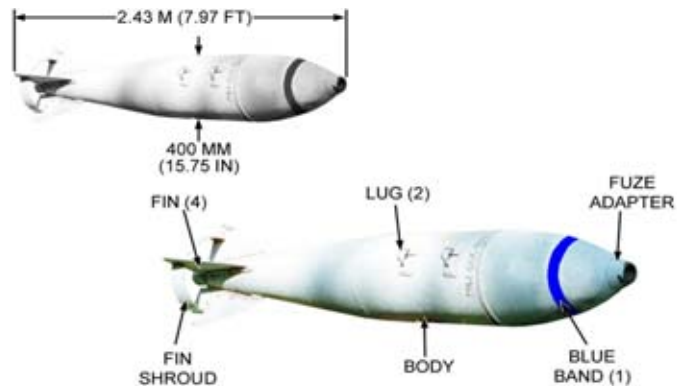

IRAQI BOMB, 500-KG, GP, BADR-28

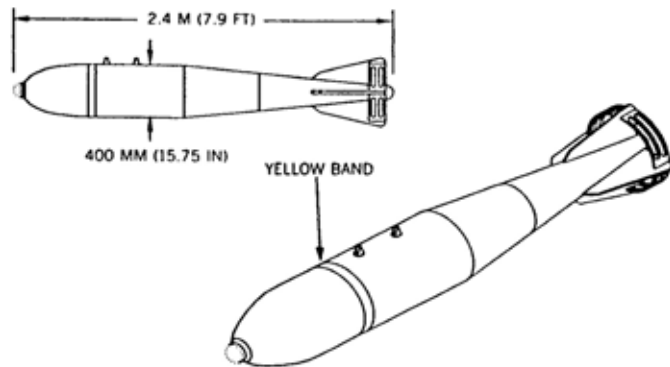

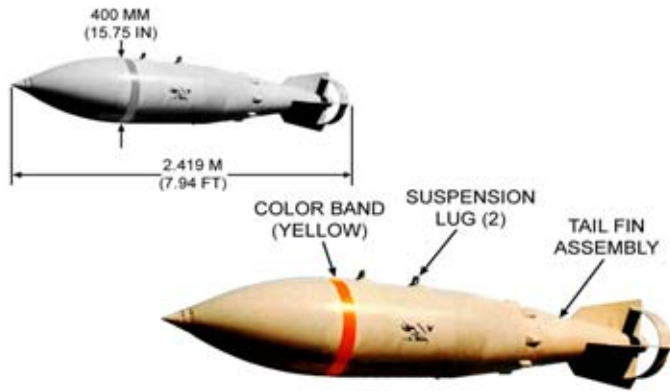

IRAQI BOMB, 500-KG, GP, NASR-7

Ordnance used with:
UNKNOWN, BOMB NOSE, TYPE UNKNOWN
UNKNOWN, FIN ASSEMBLY, CONICAL, W/NASR-7

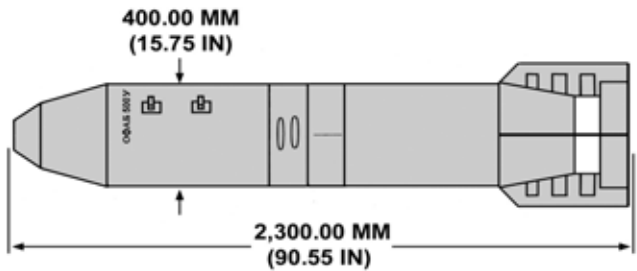

U.S.S.R. BOMB, HE-FRAG, 500-KG, OFAB500U (RETARDED)

N.E.W. 159.00 KG

FRENCH BOMB, 400-KG, BGL 400, LASER GUIDED, MATRA

Ordnance used with:
FM 80 BC, TAIL, IMPACT, ELECTRONIC
FM 80 BO, NOSE, IMPACT, ELECTRONIC
UNKNOWN, FINS, LASER GUIDED BOMBS

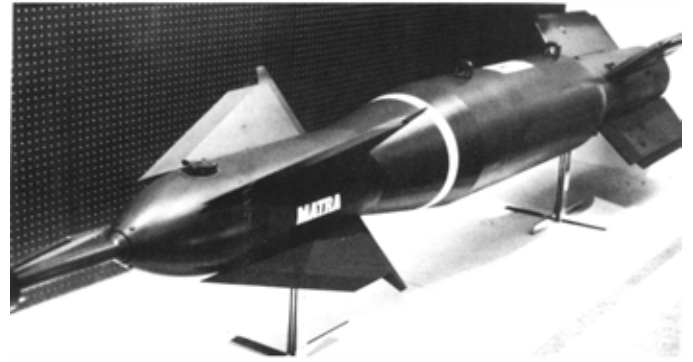

SPANISH BOMB, 400-KG, GP, BRI-400

Ordnance used with:
MU-5, BOMB, NOSE FUZE
MU05, BOMB, NOSE
VTB 1A, BOMB, NOSE, PROXIMITY
GRC-AR, BOMB, TAIL, LONG DELAY ANTIDISTURBANCE
MU 05, BOMB, NOSE, IMPACT
MF 2000, BOMB, TAIL, IMPACT
MU 09, BOMB, NOSE

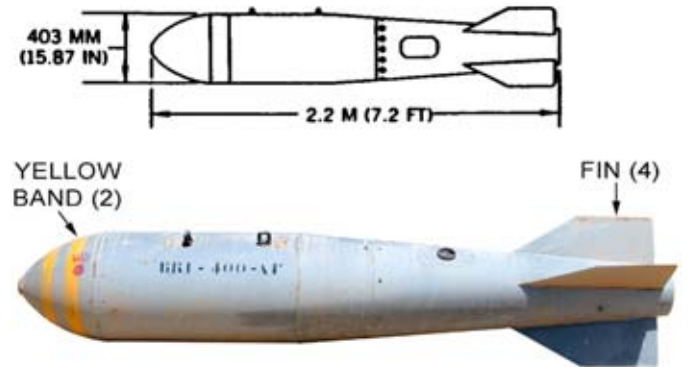

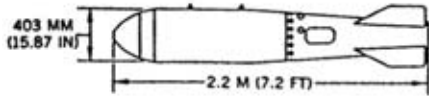

SPANISH BOMB, 400KG, HE, PARACHUTE RETARDED, BRIP-400



Ordnance used with:
INFARR, TAIL, DELAY
KAPPA 3, BOMB, NOSE, ALL WAY
KAPPA III, BOMB, NOSE, ALL WAY
MU-017, NOSE, TIME, SHORT DELAY
EP-516, BOMB, NOSE, PROXIMITY
GRL/AR, TRANSVERSE, LONG DELAY
GRL, BOMB FUZE LONG DELAY ANTI-REMOVAL

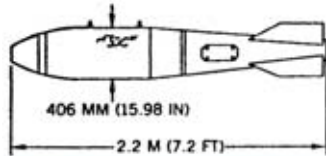

EGYPTIAN BOMB, 400-KG, GP, NASR-400



IRAQI BOMB, 400-KG, GP, NASR-400

Ordnance used with:
UNKNOWN, BOMB NOSE, TYPE UNKNOWN
UNKNOWN, FIN ASSEMBLY, CONICAL, 3-FIN
UNKNOWN, FIN ASSEMBLY, CONICAL, 4-FIN

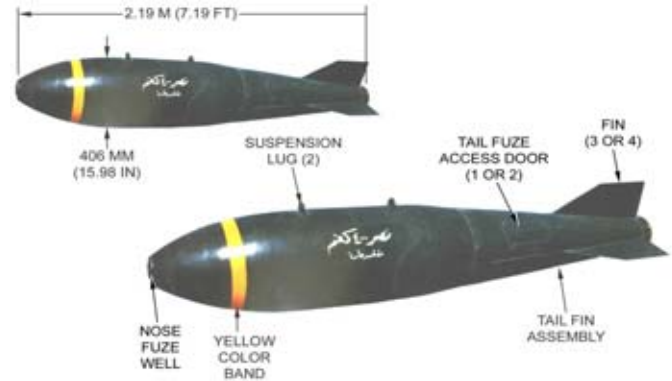

U.S. BOMB, 750-LB, GP, M117

Ordnance used with:
AN-M166, NOSE, PROXIMITY
BSU-85/B, BOMB FIN ASSEMBLY, AIR INFLATABLE RETARDER
BSU-93/B, FIN ASSEMBLY, AIR INFLATABLE RETARDER
DSU-30/B, BOMB TARGET DETECTING DEVICE
DSU-33A(D-2)/B, SENSING ELEMENT, DUMMY
DSU-33A/B, SENSING ELEMENT, PROXIMITY
FMU-112/B, BOMB FUZE, NOSE & TAIL
N.E.W. 175.00 KG



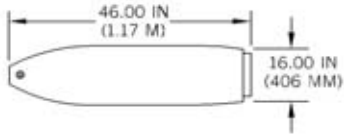

U.S. BOMB, 750-LB, GP, M117A1

Ordnance used with:

AN-M166, NOSE, PROXIMITY
 BSU-85/B, BOMB FIN ASSEMBLY, AIR INFLATABLE RETARDER
 BSU-93/B, FIN ASSEMBLY, AIR INFLATABLE RETARDER
 DSU-30/B, BOMB TARGET DETECTING DEVICE
 DSU-33A(D-2)/B, SENSING ELEMENT, DUMMY
 DSU-33A/B, SENSING ELEMENT, PROXIMITY
 FMU-112/B, BOMB FUZE, NOSE & TAIL

N.E.W. 176.00 KG

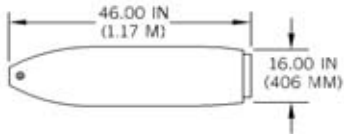

U.S. BOMBS, 750-LB, GP, M117A1E1, M117A1E2, M117A1E3, M117A2 AND M117A3

Ordnance used with:

AN-M166, NOSE, PROXIMITY
 BSU-85/B, BOMB FIN ASSEMBLY, AIR INFLATABLE RETARDER
 BSU-93/B, FIN ASSEMBLY, AIR INFLATABLE RETARDER
 DSU-30/B, BOMB TARGET DETECTING DEVICE
 DSU-33A(D-2)/B, SENSING ELEMENT, DUMMY
 DSU-33A/B, SENSING ELEMENT, PROXIMITY
 FMU-112/B, BOMB FUZE, NOSE & TAIL

N.E.W. 175.00 KG

U.K. BOMB, 1000-LB, HE, MC, MK 13

Ordnance used with:

NO. 952 MK 1, BOMB, PROXIMITY

NO. 107 MK 1, TAIL UNIT, 1000 LB MC BOMB

NO. 107 MK 2, TAIL UNIT, 1000 LB MC BOMB

NO. 107 MK 3, TAIL UNIT, 1000 LB MC BOMB

NO. 107 MK 4, TAIL UNIT, 1000 LB MC BOMB

NO. 107 MK 5, TAIL UNIT, 1000 LB MC BOMB

NO. 114 MK 2, TAIL UNIT, 1000 LB MC BOMB

N.E.W. 186.00 KG

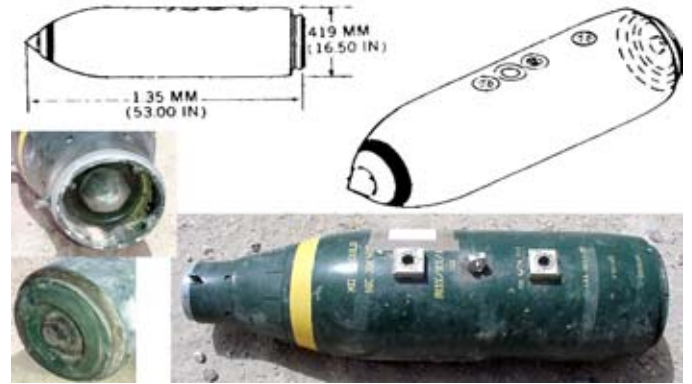

U.K. BOMB, 1000-LB, HE, MC, MK 18

Ordnance used with:

NO. 952 MK 1, BOMB, PROXIMITY

NO. 107 MK 1, TAIL UNIT, 1000 LB MC BOMB

NO. 107 MK 2, TAIL UNIT, 1000 LB MC BOMB

NO. 107 MK 3, TAIL UNIT, 1000 LB MC BOMB

NO. 107 MK 4, TAIL UNIT, 1000 LB MC BOMB

NO. 107 MK 5, TAIL UNIT, 1000 LB MC BOMB

NO. 114 MK 4, TAIL UNIT, 1000 LB MC BOMB

N.E.W. 186.00 KG

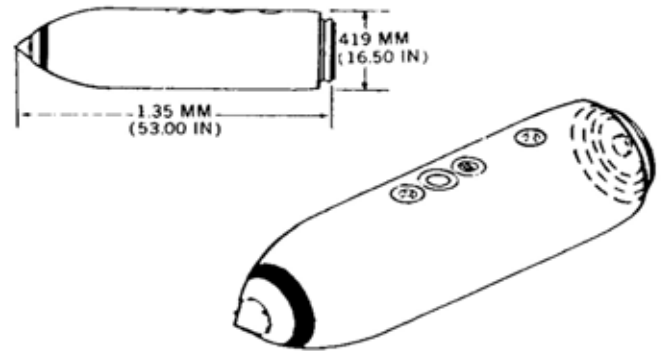

U.S.S.R. BOMB, 500-KG, GP, FAB-500 SHN

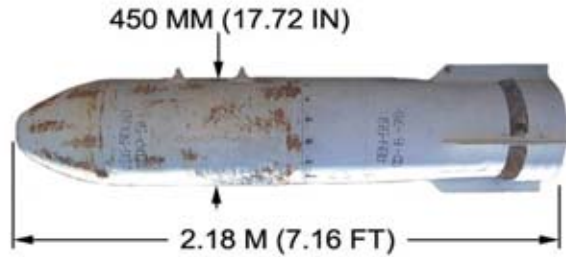

Ordnance used with:
UP-581, BOMB, FUZE
AVU-551, BOMB FUZE, TAIL

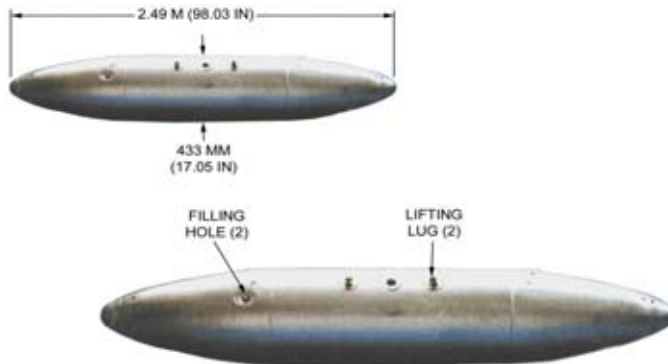

SPANISH BOMB, INCENDIARY, BIN-200

Ordnance used with:
EMBI, BOMB, NOSE/TAIL, IMPACT

U.S.S.R. BOMB, 1100-LB, GP, WELDED, FAB-500

Ordnance used with:
AGP, BOMB, NOSE
APUV, NOSE AND TAIL
APUV-1, NOSE AND TAIL
APUVM, BOMB, NOSE AND TAIL
AVU-E, NOSE AND TAIL
VDV, NOSE AND TAIL
AV 2 D/U, BOMB FUZE, NOSE AND TAIL

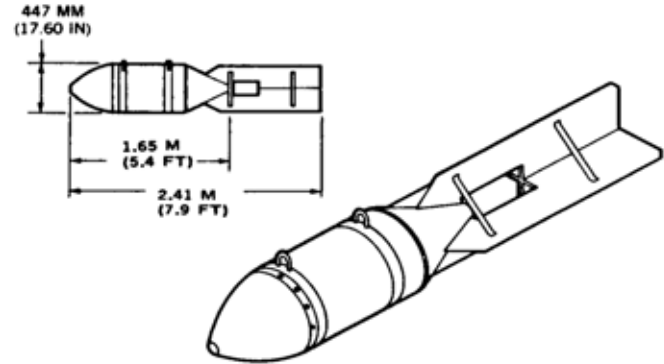

EGYPTIAN BOMB, 500-KG, APERS, KAAKAA-500

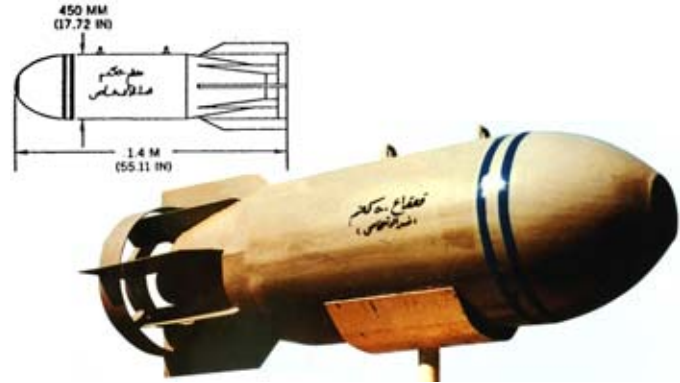

EGYPTIAN BOMB, 500-KG, GP, KAAKAA-500

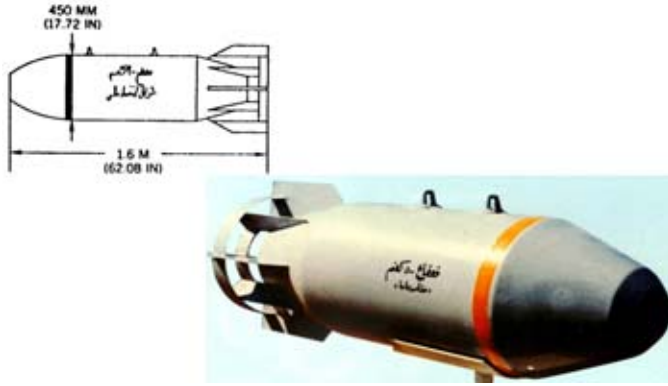

EGYPTIAN BOMB, FUEL-AIR (FAE)

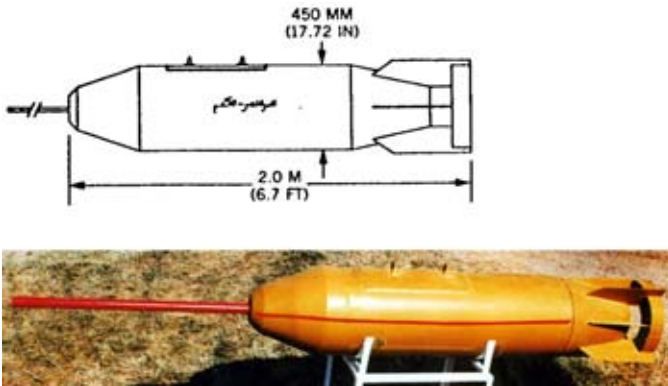

IRAQI BOMB, 420-KG, CHEMICAL, KAAKAA-500



IRAQI BOMB, 500-KG, FRAG, KAAKAA-500

Ordnance used with:
UNKNOWN, BOMB NOSE, TYPE UNKNOWN

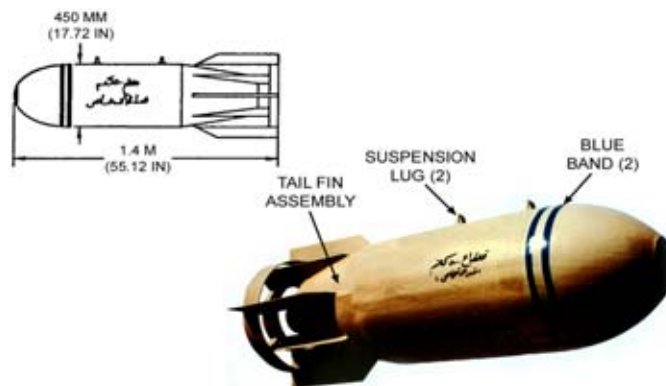

**IRAQI BOMB, GP, FUEL AIR EXPLOSIVE (FAE),
MODEL UNKNOWN**

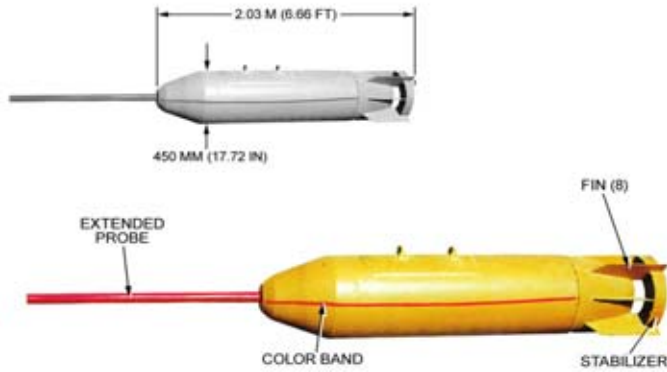

SPANISH BOMB, 500-KG, AP, BNI-500

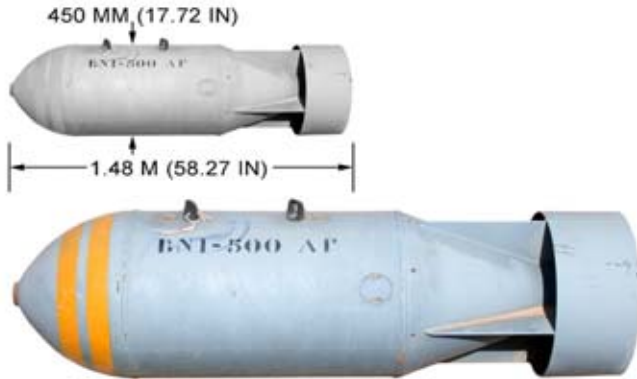

U.S.S.R. BOMB, CHEMICAL, KHAB-500

Ordnance used with:
AGM 1, BOMB, NOSE
AGM 3, BOMB, NOSE
AM-A, BOMB, NOSE
AM A B/V, BOMB, NOSE
AM B, BOMB, NOSE
AM B B/V, BOMB, NOSE
TM-24A, BOMB, NOSE OR TAIL
N.E.W. 1.40 KG

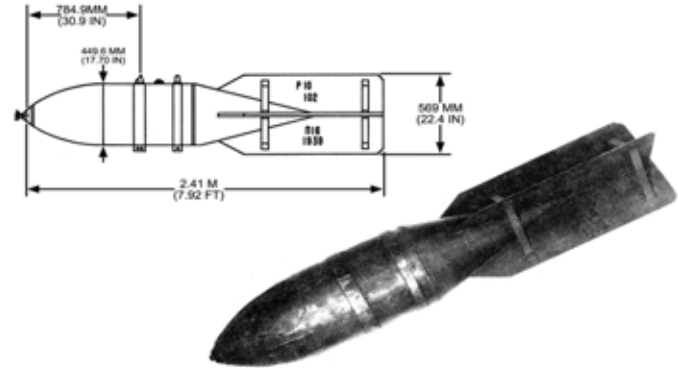

EGYPTIAN BOMB, 1000-KG, PENETRATOR, GP, NASR-1000P

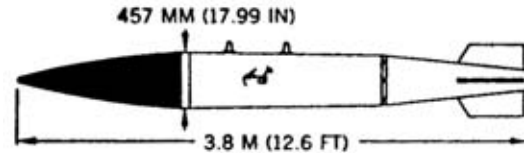

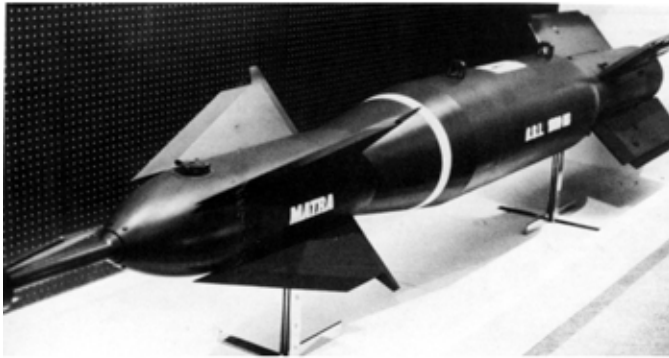

FRENCH BOMB, 1000-KG, LASER-GUIDED, MATRA

Ordnance used with:
FM 80 BC, TAIL, IMPACT, ELECTRONIC
FM 80 BO, NOSE, IMPACT, ELECTRONIC

N.E.W. 250.00 KG

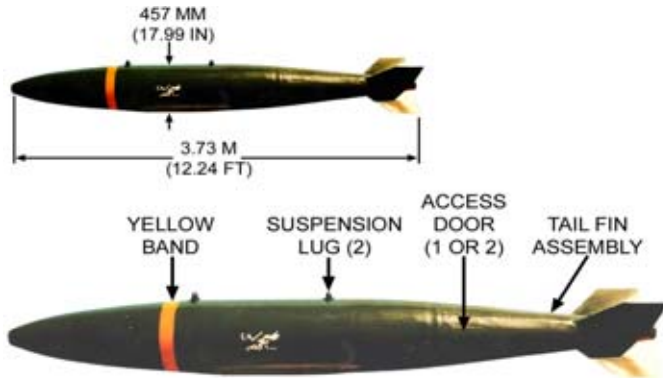

IRAQI BOMB, 880-KG, GP, NASR-28

Ordnance used with:
UNKNOWN, FIN ASSEMBLY, CONICAL
UNKNOWN, BOMB NOSE, TYPE UNKNOWN

U.S. BOMB UNIT, GUIDED, GBU-24/B

Ordnance used with:

FMU-139/B, NOSE & TAIL, IMPACT

FMU-139A/B, NOSE & TAIL, IMPACT

FMU-143/B, BOMB FUZE, NOSE & TAIL, IMPACT

FMU-143A/B, BOMB FUZE, NOSE & TAIL, IMPACT

FMU-143B/B, NOSE & TAIL, IMPACT

FMU-143D/B, BOMB FUZE, NOSE & TAIL, IMPACT

FMU-143E/B, NOSE & TAIL, IMPACT

N.E.W. 430.00 KG

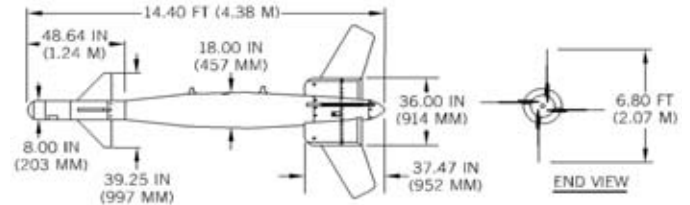

U.S. BOMB UNITS, GUIDED, GBU-10/B & GBU-10A/B

Ordnance used with:

FMU-139/B, NOSE & TAIL, IMPACT

FMU-139A/B, NOSE & TAIL, IMPACT

FMU-26/B, BOMB FUZE, NOSE & TAIL, MULTIPURPOSE

FMU-26A/B, BOMB FUZE, NOSE & TAIL, MULTIPURPOSE

FMU-26B/B, BOMB FUZE, NOSE & TAIL, MULTIPURPOSE

FMU-81/B, BOMB FUZE, NOSE & TAIL, IMPACT, SHORT-DELAY

M905, TAIL, IMPACT

N.E.W. 430.00 KG

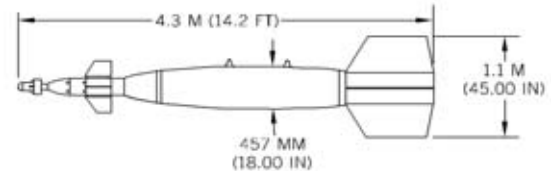

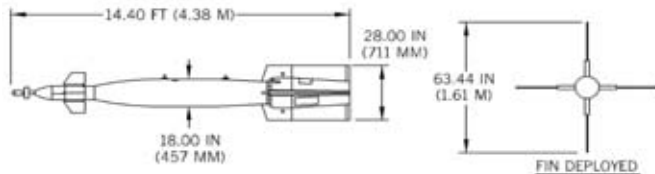

GBU-10C/B, -10D/B, AND -10E/B

U.S. BOMB UNITS, GUIDED, GBU-10C/B, D/B, AND E/B

Ordnance used with:

FMU-139/B, NOSE & TAIL, IMPACT

FMU-139A/B, NOSE & TAIL, IMPACT

FMU-26B/B, BOMB FUZE, NOSE & TAIL, MULTIPURPOSE

FMU-81/B, BOMB FUZE, NOSE & TAIL, IMPACT, SHORT-DELAY

M905, TAIL, IMPACT

MK 344 MOD 0, BOMB FUZE, TAIL, ELECTRIC

MK 344 MOD 1, BOMB FUZE, TAIL, ELECTRIC

N.E.W. 430.00 KG

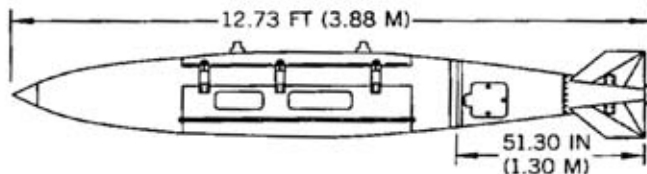

U.S. BOMB UNITS, GUIDED, GBU-31(V)1/B AND GBU-31(V)2/B (JDAM)

Ordnance used with:

DSU-33A/B, SENSING ELEMENT, PROXIMITY

FMU-139A/B, NOSE & TAIL, IMPACT

DSU-33B/B, SENSING ELEMENT, PROXIMITY

FMU-139B/B, BOMB, NOSE/TAIL

MK 84, 2000-LB, GP

KMU-556/B, GUIDANCE SET

N.E.W. 945.00 LB

U.S. BOMB, 2000-LB, GP (LOW DRAG), MK 84

Ordnance used with:
AN-M166, NOSE, PROXIMITY
BSU-50/B, FIN ASSEMBLY, AIR INFLATABLE RETARDER
DSU-30/B, BOMB TARGET DETECTING DEVICE
DSU-33A(D-2)/B, SENSING ELEMENT, DUMMY
DSU-33A/B, SENSING ELEMENT, PROXIMITY
FMU-112/B, BOMB FUZE, NOSE & TAIL
FMU-113/B, PROXIMITY

N.E.W. 429.00 KG

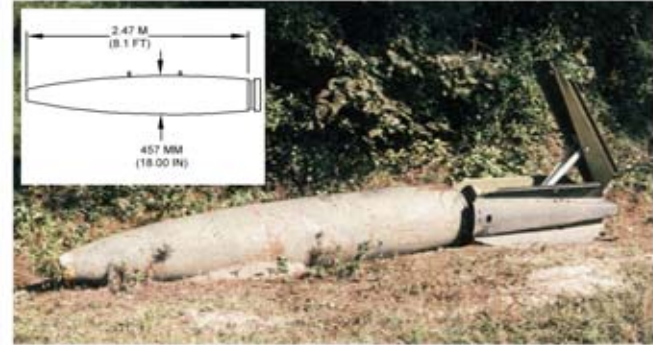

U.S. BOMB, 2000-LB, GP, BLU-117A/B

Ordnance used with:
FMU-139/B, NOSE & TAIL, IMPACT
FMU-139A/B, NOSE & TAIL, IMPACT
GBU-10/B, BOMB UNIT, GUIDED
GBU-10A/B, BOMB UNIT, GUIDED
GBU-10C/B, BOMB UNIT, GUIDED
GBU-10D/B, BOMB UNIT, GUIDED
GBU-10E/B, BOMB UNIT, GUIDED

N.E.W. 901.00 LB

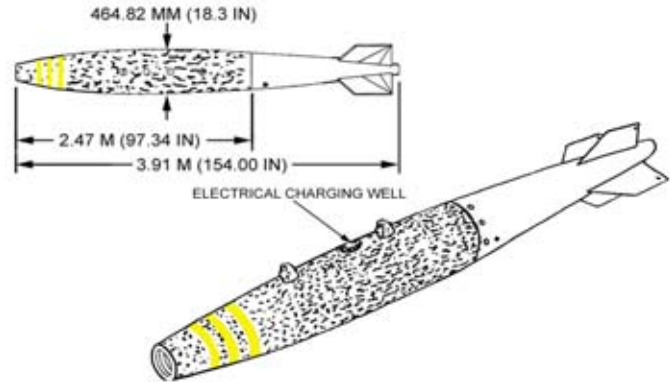

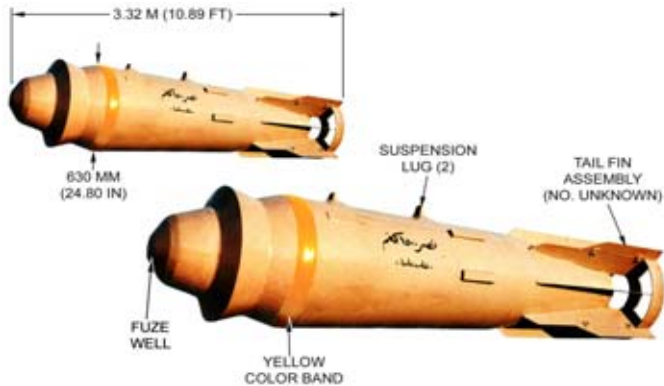

IRAQI BOMB, 1500-KG, GP, NASR-1500

Ordnance used with:
UNKNOWN, BOMB NOSE, TYPE UNKNOWN

N.E.W. 658.00 KG

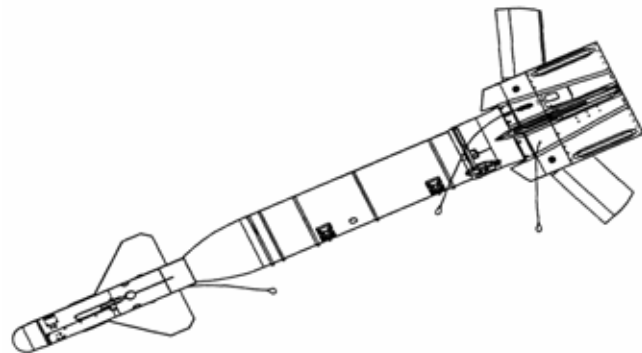

U.S. BOMB UNIT, GUIDED, EHTGB, GBU-27A/B

Ordnance used with:
BLU-109/B, PENETRATOR
BLU-109A/B, PENETRATOR
WGU-39A/B, GUIDANCE CONTROL UNIT
BSU-88A/B, AIRFOIL GROUP

N.E.W. 245.00 KG

IRAQI BOMB, 3000-KG, GP, NASR-3000

Ordnance used with:
UNKNOWN, BOMB NOSE, TYPE UNKNOWN

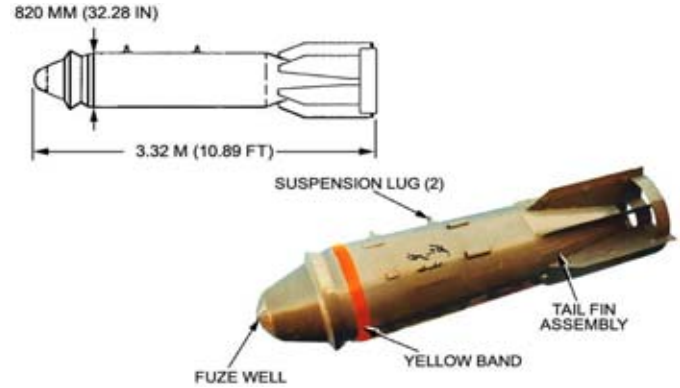

N.E.W. 1350.00 KG

IRAQI BOMB, 5000-KG, GP, NASR-5000

Ordnance used with:
UNKNOWN, BOMB NOSE, TYPE UNKNOWN

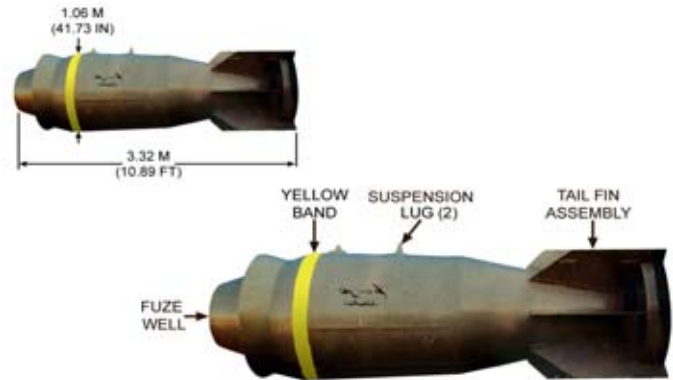

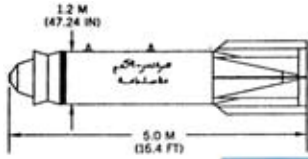

EGYPTIAN BOMB, 9000-KG, GP, NASR-9000

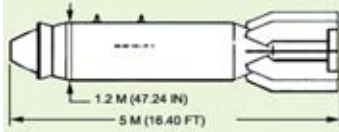

IRAQI BOMB, 9000-KG, GP, NASR-9000

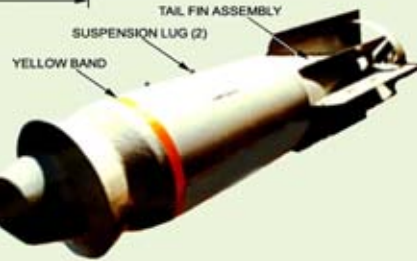

Ordnance used with:
UNKNOWN, BOMB NOSE, TYPE UNKNOWN