

IRANIAN GRENADE, RIFLE, HEAT, MODEL UNKNOWN



IRAQI GRENADE, HAND, ILLUMINATION, MODEL UNKNOWN



DIMENSIONS UNKNOWN

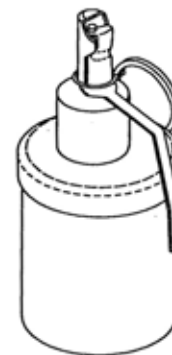

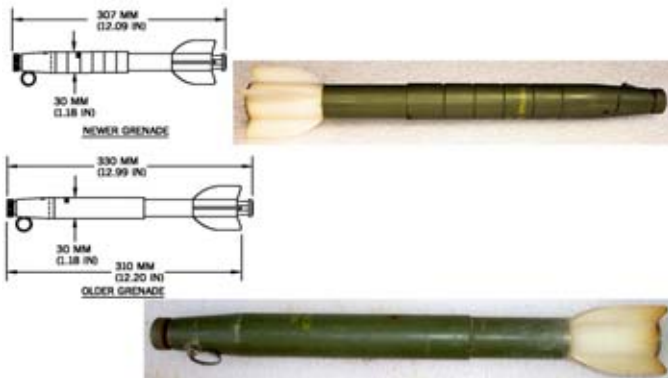

YUGOSLAV GRENADE, RIFLE, 30-MM, HE, TTM, M60P1

Ordnance used with:
 M70P1, GRENADE, PD
 UT,M70P1, GRENADE, PD
 UT M2, GRENADE, PD
 UT, M2, GRENADE, PD
 UT M94T-CH, GRENADE, PD
 UT M3, GRENADE, PD
 UT,M3, GRENADE, PD

N.E.W. 60.00 G

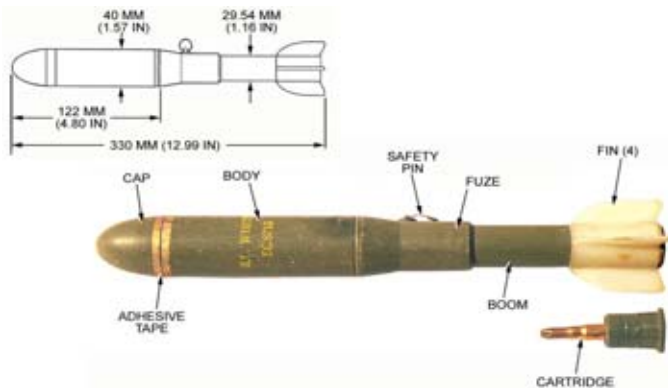

YUGOSLAV GRENADE, RIFLE, 40-MM, ILLUMINATION, M62

Ordnance used with:
 OU,M62, BASE INITIATING

N.E.W. 0.22 LB

YUGOSLAV GRENADE, RIFLE, SMOKE, M62

Ordnance used with:
DU,M62, BASE-INITIATING, PYROTECHNIC DELAY
DI,M62, BASE-INITIATING, PYROTECHNIC DELAY



CHINESE GRENADE, HAND, FRAG, TYPE 82-1



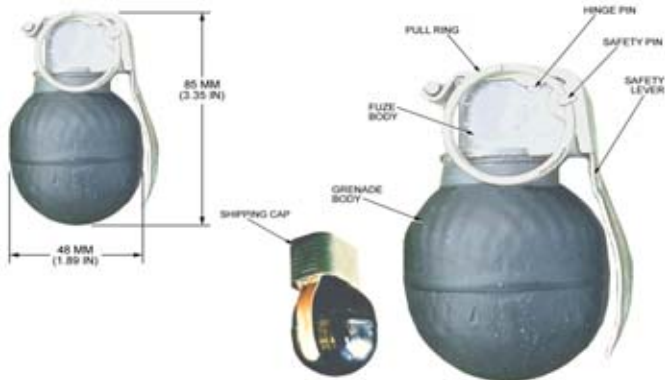

CHINESE GRENADE, HAND, FRAG, TYPE 82-2 (TYPE 82-2S)

N.E.W. 62.00 G

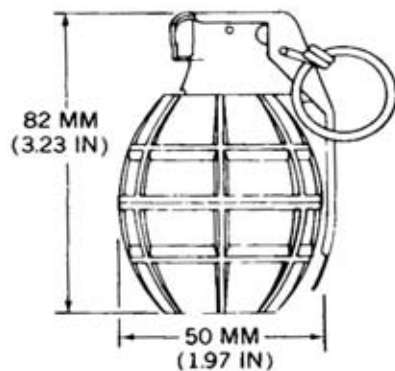

BELGIAN GRENADE, HAND, FRAG, MODEL PRB NR 423

Ordnance used with:
PRB NR 2432, GRENADE, STRIKER-RELEASE

N.E.W. 60.00 G

IRAQI GRENADE, HAND, FRAG, MODEL UNKNOWN

Ordnance used with:
UZRGM, GRENADE, STRIKER-RELEASE

N.E.W. 36.05 G

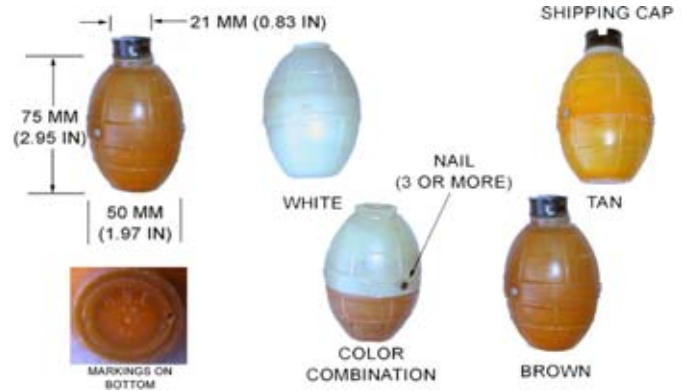

UNKNOWN COUNTRY GRENADE, HAND, TRAINING, MODEL UNKNOWN





CHINESE GRENADE, HAND, FRAG, TYPE 86P

Ordnance used with:
86P, GRENADE, STRIKER-RELEASE



N.E.W. 39.28 G



EGYPTIAN GRENADE, HAND, FRAG, NO. 2



N.E.W. 42.00 G

BULGARIAN GRENADE, HAND, FRAG, RGO-78

Ordnance used with:
DVM, GRENADE, STRIKER-RELEASE
UZRGM, GRENADE, STRIKER-RELEASE

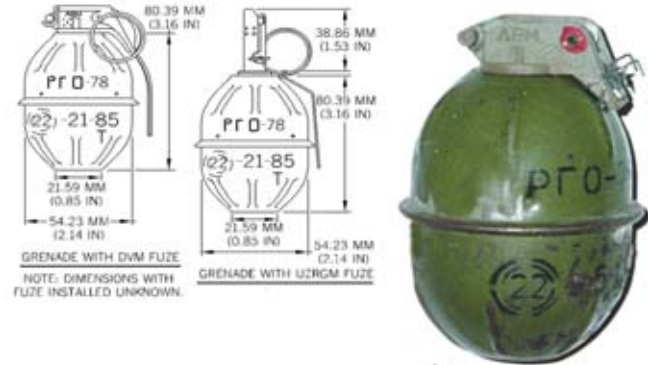

N.E.W. 82.00 G

BULGARIAN GRENADE, HAND, PRACTICE, RGO-78IM

Ordnance used with:
UNKNOWN, GRENADE, STRIKER-RELEASE, PRACTICE





**NETHERLANDS GRENADE, HAND, SMOKE,
PHOSPHORUS, NO. 80 MK 1**

Ordnance used with:
NO. 2 MK 1/1, GRENADE, STRIKER-RELEASE

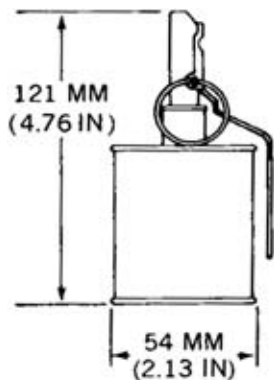

U.S.S.R. GRENADE, HAND, DEFENSIVE, RG-42

Ordnance used with:
UZRG, GRENADE, STRIKER-RELEASE
UZRGM, GRENADE, STRIKER-RELEASE
FGM-1, GRENADE, STRIKER-RELEASE

N.E.W. 120.00 G

BELGIAN GRENADE, RIFLE, HE-FRAG, ROCKET ASSISTED, HE-RFL-55 LR BTU, M287

Ordnance used with:
F55, GRENADE, PIBD

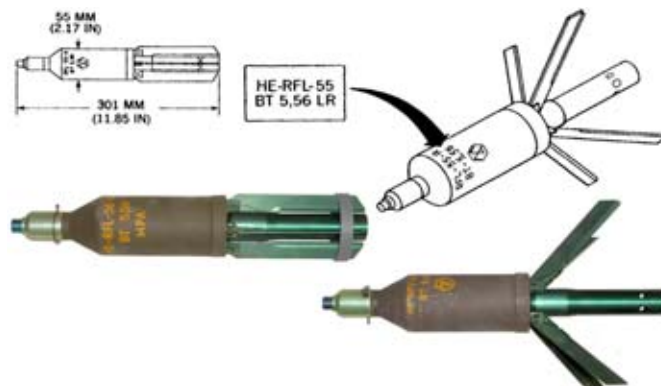

N.E.W. 158.00 G

RUSSIAN GRENADE, HAND, PRACTICE, URG

Ordnance used with:
UNKNOWN, GRENADE, STRIKER-RELEASE, PRACTICE





RUSSIAN GRENADE, HAND, PRACTICE, URG-N

Ordnance used with:
UNKNOWN, GRENADE, STRIKER-RELEASE, PRACTICE

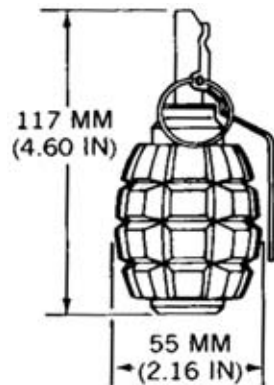

U.S.S.R. GRENADE, HAND, DEFENSIVE, F-1; ROMANIAN GRENADE, TIP F-1

Ordnance used with:
F-IN-60, 55MM, RIFLE, FRAG
UZRG, GRENADE, STRIKER-RELEASE
UZRGM, GRENADE, STRIKER-RELEASE
UZRGM-2, GRENADE, STRIKER-RELEASE
FGM-1, GRENADE, STRIKER-RELEASE

N.E.W. 50.00 G

CZECHOSLOVAKIAN GRENADE, HAND, MOD RG-4

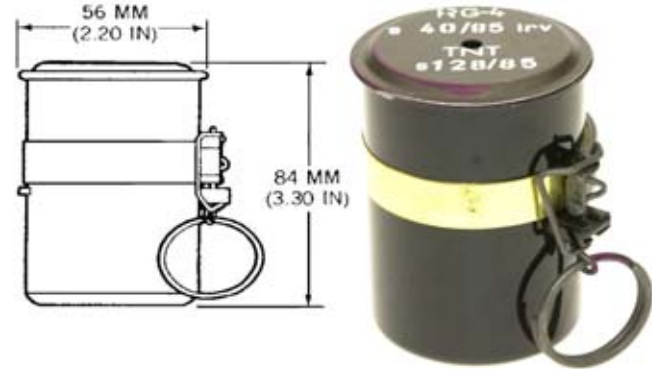

N.E.W. 51.00 G

YUGOSLAV GRENADE, HAND, FRAG, BRM 75

Ordnance used with:
M62, GRENADE, PERCUSSION
PU,M62, GRENADE, PERCUSSION
UBRV-M75, GRENADE, STRIKER-RELEASE



N.E.W. 43.20 G

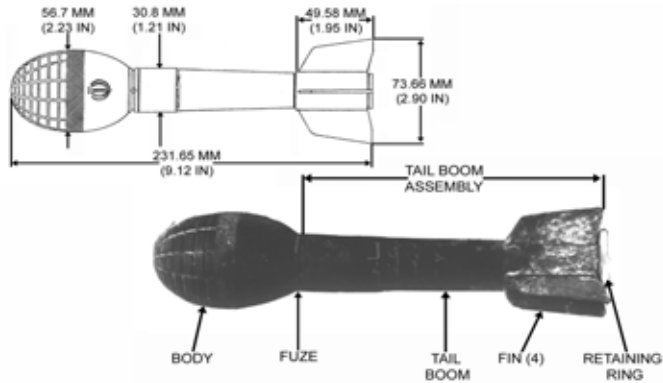

IRANIAN GRENADE, RIFLE, HE-FRAG, SA-100

Ordnance used with:
SA-100, HAND, FRAG
UNKNOWN, GRENADE, BD

N.E.W. 43.61 G



UNKNOWN COUNTRY GRENADE, HAND, FRAG, MODEL UNKNOWN

Ordnance used with:
MODEL UNKNOWN, GRENADE, HAND, STRIKER-RELEASE

N.E.W. 41.64 G

**UNKNOWN COUNTRY GRENADE, HAND, TRAINING,
MODEL UNKNOWN**



YUGOSLAV GRENADE, HAND, BLAST, M75

Ordnance used with:
UBRV-M75, GRENADE, STRIKER-RELEASE



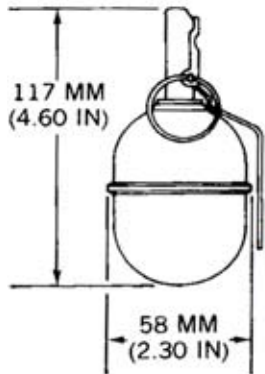

U.S.S.R. GRENADE, HAND, DEFENSIVE, RGD-5

Ordnance used with:
DVM, GRENADE, STRIKER-RELEASE
UZRG, GRENADE, STRIKER-RELEASE
UZRGM, GRENADE, STRIKER-RELEASE

N.E.W. 111.00 G



U.S.S.R. GRENADE, HAND, PRACTICE, RG-42

EGYPTIAN GRENADE, HAND, FRAG, NO. 1

Ordnance used with:
UNKNOWN, GRENADE, STRIKER-RELEASE

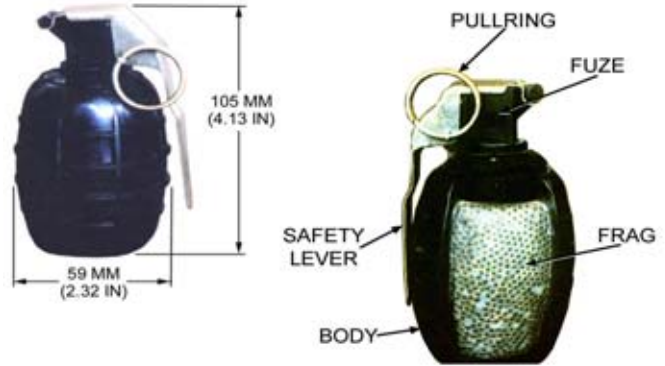

N.E.W. 65.00 G

GERMAN GRENADE, HAND, SMOKE, L84A1

Ordnance used with:
UNKNOWN, GRENADE, STRIKER-RELEASE





ITALIAN GRENADE, HAND, SMOKE, VS-MK-83



U.K. GRENADE, HAND, SMOKE, COLORED, MODEL UNKNOWN

U.S.S.R. GRENADE, HAND, FRAG, RGN

Ordnance used with:

UDZ, GRENADE, STRKR-REL, ALL-WAY ACTING, SELF DEST
UDZ-S, GRENADE, STRKR-REL, ALL-WAY ACTING, SELF DEST

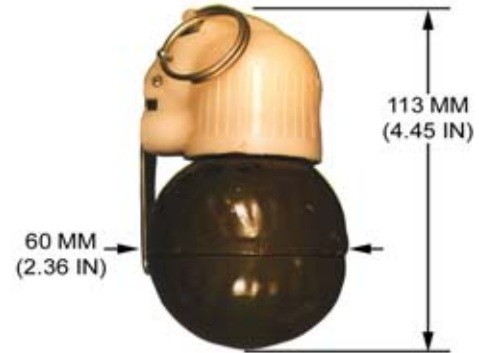

N.E.W. 114.00 G

U.S.S.R. GRENADE, HAND, FRAG, RGO

Ordnance used with:

UDZ, GRENADE, STRKR-REL, ALL-WAY ACTING, SELF DEST
UDZ-S, GRENADE, STRKR-REL, ALL-WAY ACTING, SELF DEST

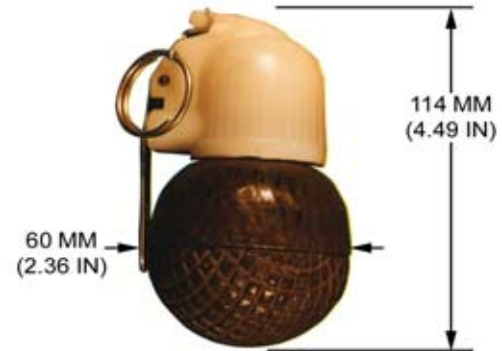

N.E.W. 92.00 G



YUGOSLAV GRENADES, RIFLE, HEAT, M60; AND PRACTICE, M68

Ordnance used with:
 DI-M60, BD, GRENADE, RIFLE
 DIM60, BD, GRENADE, RIFLE
 UNDESIGNATED, GRENADE, BD

N.E.W. 246.00 G

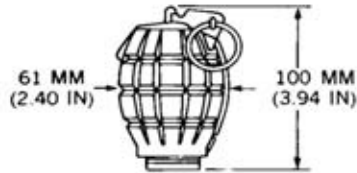

U.K./PAKISTANI GRENADE, HAND, APERS, FRAG, NO. 36M, MK 1

N.E.W. 73.00 G

EGYPTIAN GRENADE, HAND, HEAT, TYPE 1 (HOSAM)

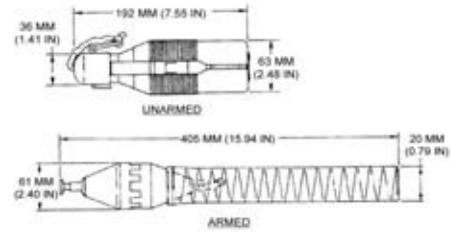

N.E.W. 181.00 G

EGYPTIAN GRENADE, HAND, HEAT, TYPE 2 (HOSAM)

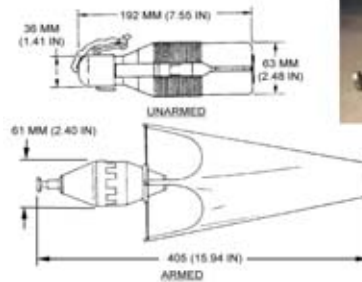

N.E.W. 143.00 G

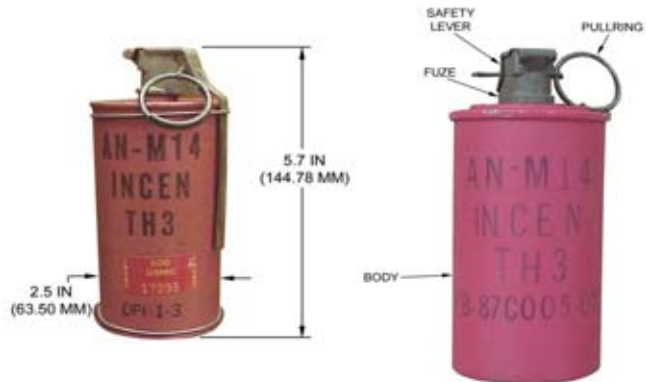

U.S. GRENADE, HAND, INCENDIARY, AN-M14

Ordnance used with:
 M201A1E2, GRENADE, STRIKER-RELEASE
 M201A1, GRENADE, STRIKER-RELEASE
 AN-M14, HAND, BODY, INCENDIARY

N.E.W. 0.48 G

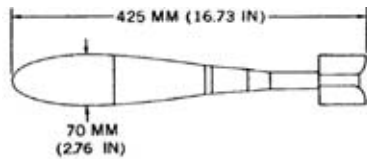

SWISS GRENADE, RIFLE, HEAT, P-70-F



N.E.W. 270.00 G

U.S.S.R. GRENADES, HAND, HEAT, RKG-3, RKG-3M & RKG-3T

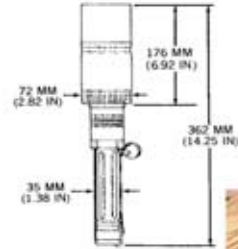

N.E.W. 604.00 G

PAKISTANI GRENADE, RIFLE, HEAT, P2 MK 1

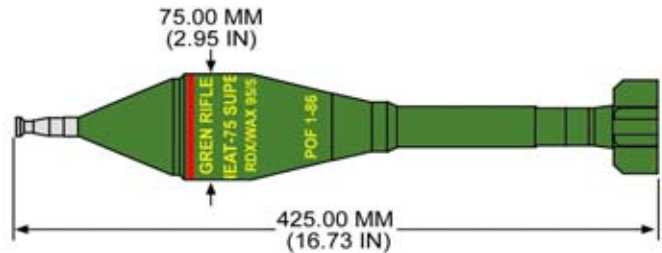



UNKNOWN COUNTRY GRENADE, HAND, TRAINING, MODEL UNKNOWN

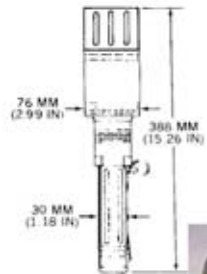

U.S.S.R. GRENADE, HAND, HEAT, RKG-3EM

N.E.W. 434.00 G

U.S.S.R. GRENADE, PRACTICE, HAND, UPG-8

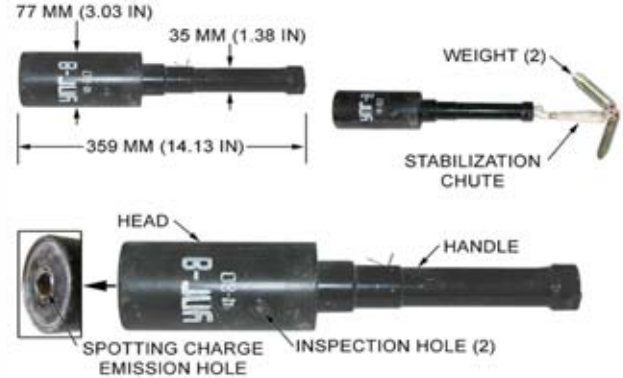

U.S.S.R. GRENADE, PROJECTED, 80-MM, SMOKE, 3D6

Ordnance used with:
T-90, MAIN BATTLE TANK
T-80UD, MAIN BATTLE TANK
T-84, MAIN BATTLE TANK
BMP-1P, INFANTRY FIGHTING VEHICLE
BMP-2, INFANTRY FIGHTING VEHICLE
BMP-3 ICV, INFANTRY FIGHTING VEHICLE
BMD-3 ACV, ARMORED CAVALRY VEHICLE



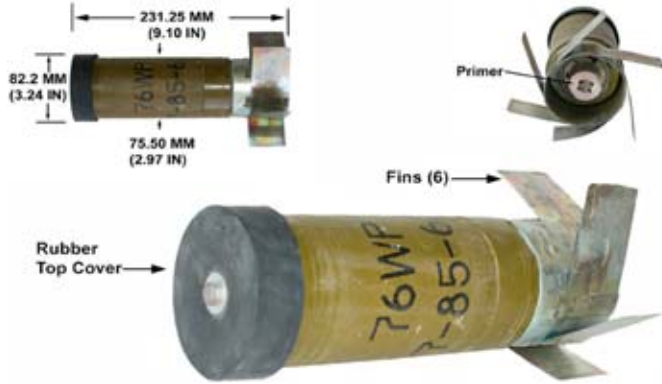

**UNKNOWN COUNTRY GRENADE, 76-MM,
DISCHARGER, SMOKE (WP), 76WP**

N.E.W. 14.00 G

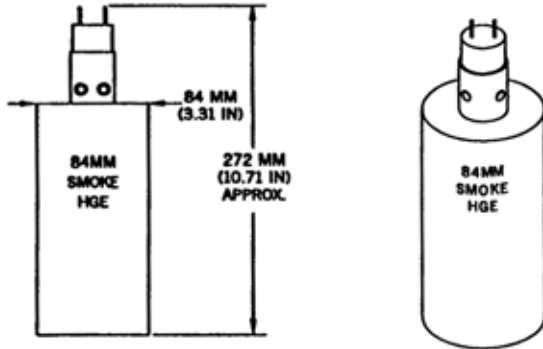

**IRAQI GRENADE, PROJECTED, 84-MM, SMOKE,
MODEL UNKNOWN**

U.K. GRENADE, 89-MM, HEAT, SPIGOT, MK IV (PIAT)

Ordnance used with:
NO. 426 MK 1, GRENADE, PD

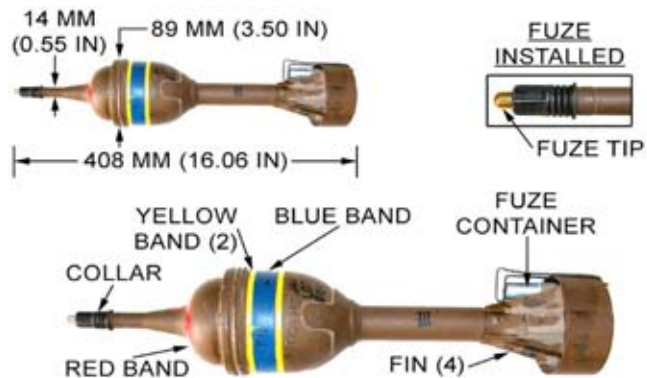

N.E.W. 452.73 G