

## BULGARIAN CARTRIDGE, 100-MM, HEAT, UBK-4

Ordnance used with:  
GPV-2, PROJECTILE, PIBD, SPITBACK  
AP.HC4.5CU, 100MM, HEAT-FS-T  
APHC5CU, 100MM, HEAT-FS-T  
BK-5, 100MM, HEAT-FS-T

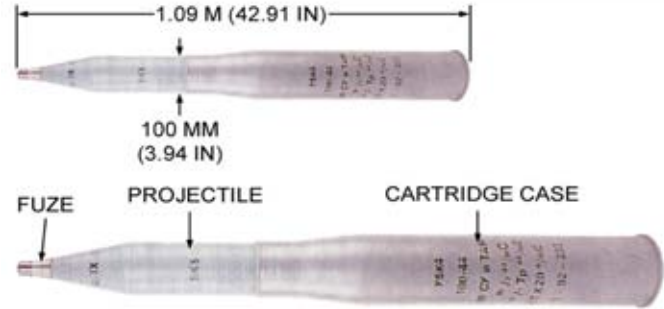

## U.S.S.R. CARTRIDGE, 115-MM, APFSDS-T, UBM-9

Ordnance used with:  
3BM21, 115-MM, APFSDS  
BM-21, 115-MM, APFSDS

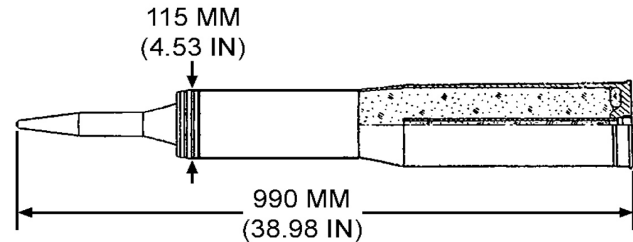

## U.S.S.R. CARTRIDGE, 122 MM, HE-FRAG, VOF-462A



Ordnance used with:  
OF-462A, 122-MM, HE, FRAG  
ZH-463, 122MM, PROPELLING CHARGE

---

## U.S.S.R. CARTRIDGE, 37-MM, AP-T, BZT



Ordnance used with:  
BZT, 37-MM, AP-T

## U.S.S.R. PROJECTILE, 115-MM, APFSDS-T, BM-21

Ordnance used with:  
3UBM9, CARTRIDGE, 115-MM, APFSDS  
UBM-9, CARTRIDGE, 115-MM, APFSDS

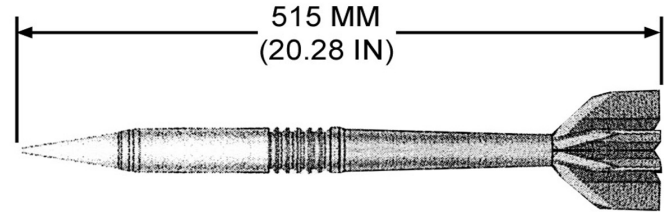

---

## YUGOSLAV CARTRIDGE, 100-MM, HEAT-T, M69

Ordnance used with:  
AU-16, PROJECTILE, PIBD  
M69, PROJECTILE, PIBD  
UT PE M69, PROJECTILE, PIBD  
UT-PE.M69, PROJECTILE, PIBD  
M69, 100-MM, HEAT-T

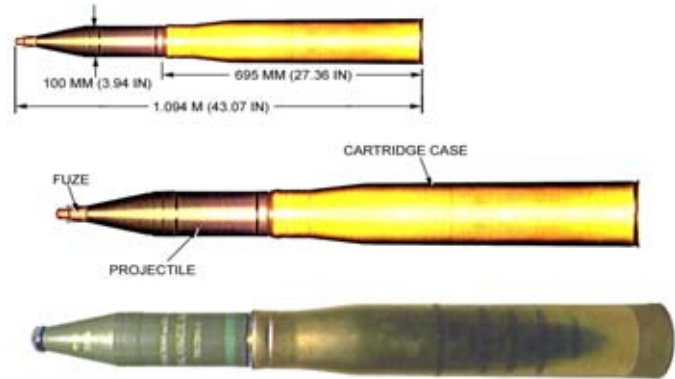



## YUGOSLAV CARTRIDGE, 90-MM, HEAT-T, M74

Ordnance used with:  
 M74, 90-MM, HEAT-T  
 AU-16, PROJECTILE, PIBD  
 M69, PROJECTILE, PIBD  
 UT PE M69, PROJECTILE, PIBD  
 UT-PE.M69, PROJECTILE, PIBD

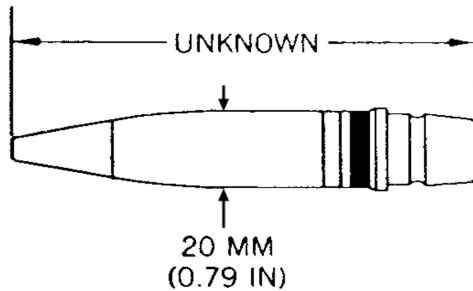

## SWISS PROJECTILE, 20-MM, APHEI-T (PSBLH/B)

Ordnance used with:  
 PSBLH/B, CARTRIDGE, 20-MM, APHEI-T  
 BZ-0144, PROJECTILE, BD



## BULGARIAN PROJECTILE, 23-MM, HEI-T, OFZT

Ordnance used with:  
MG-25, PROJECTILE, PDSD  
OFZT, CARTRIDGE, 23MM, HEI-T

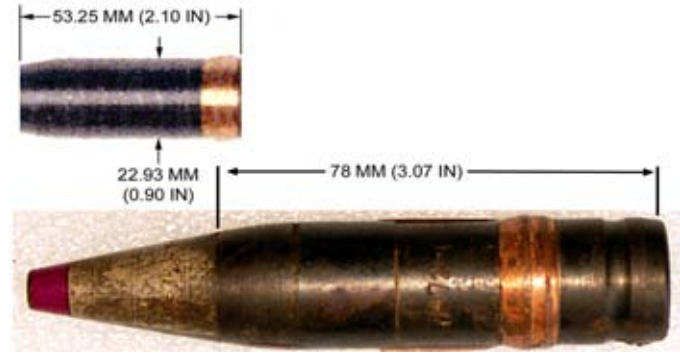

## CHINESE IGNITION CARTRIDGE, 82-MM, MORTAR, MODEL UNKNOWN

Ordnance used with:  
TH521, 82-MM, HE  
TYPE 53, 82-MM, HE  
TYPE 53, 82 MM, SMOKE, WP  
TYPE 53, 82MM, ILLUM, MORTAR  
UNKNOWN, 82 MM, MORTAR, ILLUM  
TYPE 53, 82MM, CARTRIDGE, HE, MORTAR





## U.S.S.R. CARTRIDGE, 23-MM, API-T, BZT

Ordnance used with:

BZT, 23-MM, API-T

ZUR-23-2S, GUN/MISSILE AIR DEFENSE SYSTEM, 23...

ZU-23, AIR DEFENSE GUN, 23MM, TWIN, TOWED

ZSU-23-4, AIR DEFENSE GUN, 23MM, QUAD, SELF-P...

SKYWIPE, AIR DEFENSE GUN, 23MM, TWIN, TOWED

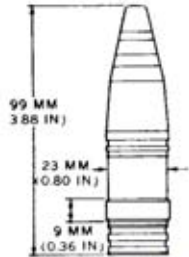

## U.S.S.R. PROJECTILE, 23-MM, API, BZA-23



## U.S.S.R. PROJECTILE, 23-MM, API-T, BZT

Ordnance used with:  
BZT, 23MM X 152BMM, CARTRIDGE, API-T

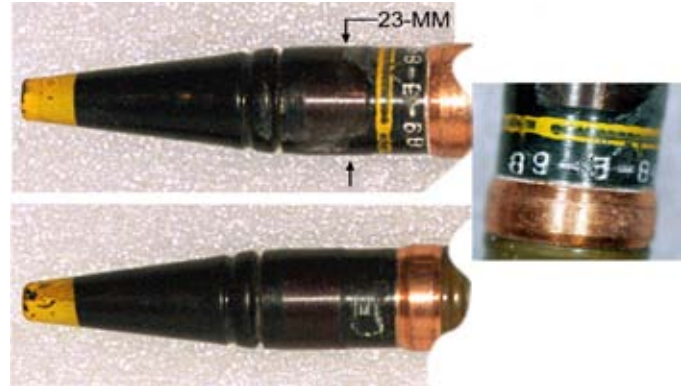

## U.S.S.R. PROJECTILE, 23-MM, FRAG-HEIT, OFZT

Ordnance used with:  
OFZT, CARTRIDGE, 23MM X 152MM, FRAG-HEIT  
B-23A, FUZE, PROJECTILE, PD  
MG-25, FUZE, PROJECTILE, PDS  
OFZT, 23-MM, CARTRIDGE, HEI-T  
OFZT, 23MM X 115MM, CARTRIDGE, HEI-T  
B-23M, PROJECTILE, PD

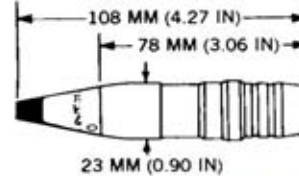

N.E.W. 13.00 G

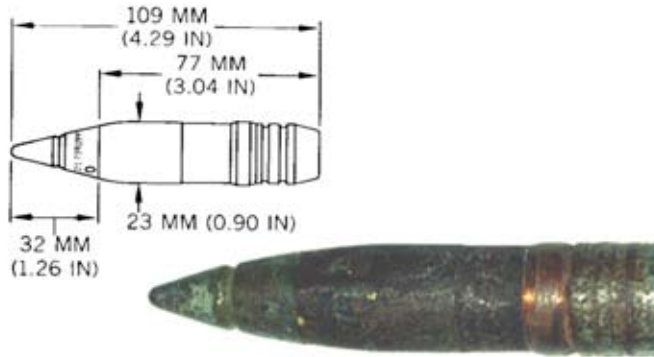

### U.S.S.R. PROJECTILE, 23-MM, HEI-FRAG, OFZ

Ordnance used with:  
 V-19U, PROJECTILE, PDS  
 OFZ, CARTRIDGE, 23-MM, HEI, (23MM X 152MM)  
 V19UK, PROJECTILE, PDS  
 B-23M, PROJECTILE, PD

N.E.W. 19.00 G

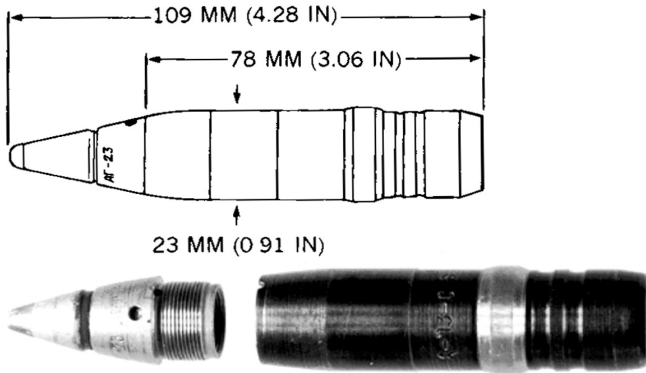

### U.S.S.R. PROJECTILE, 23-MM, FRAG-HEI, OFZ

Ordnance used with:  
 OFZ, CARTRIDGE, 23-MM, HEI (23MM X 115MM)  
 AG-23, PROJECTILE, PD

**U.S. CARTRIDGE, 25-MM, HEI, PGU-25/U**

Ordnance used with:  
M505A3, PROJECTILE, PDSQ

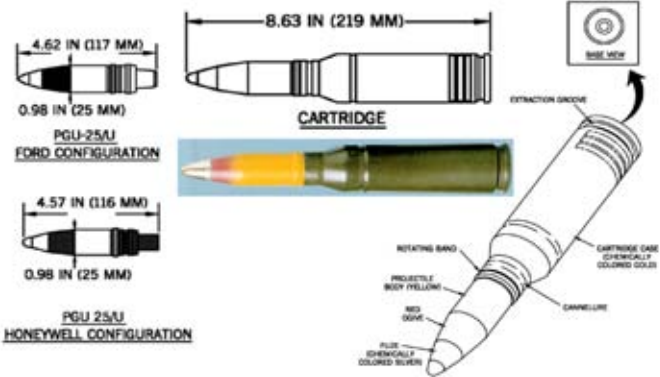

N.E.W. 131.00 G

**U.S. CARTRIDGE, 25-MM, HEI, PGU-25A/U**

Ordnance used with:  
M505A3, PROJECTILE, PDSQ

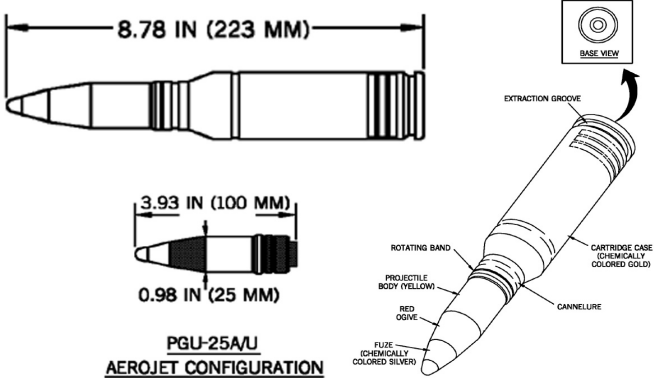

N.E.W. 131.00 G

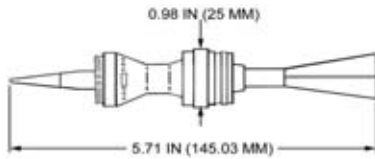

## U.S. PROJECTILE, 25-MM, APFSDS-T, M919 (2ND MODIFIED)

Ordnance used with:  
M919, 2ND MODIFIED, CARTRIDGE, 25MM, APFSDS-T

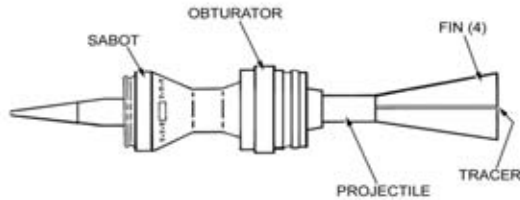

N.E.W. 2.00 G

---

## U.S.S.R. CARTRIDGE, 23-MM, FRAG-HEI, OFZ

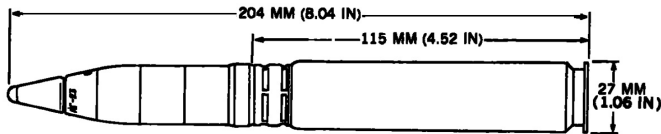

Ordnance used with:  
AG-23, PROJECTILE, PD  
OFZ, 23-MM, FRAG-HEI



## U.S.S.R. CARTRIDGE, 23-MM, HEI-T, OFZT

Ordnance used with:  
B-23A, FUZE, PROJECTILE, PD  
OFZT, 23-MM, HEI-T

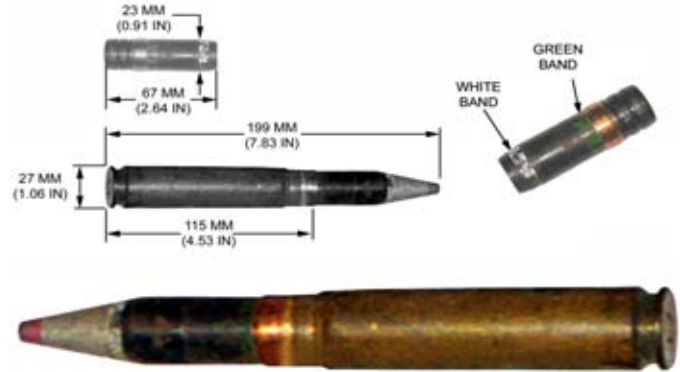

## RUSSIAN CARTRIDGE, 30-MM, HEI, OFZ

Ordnance used with:  
A-30U, PROJECTILE, PD

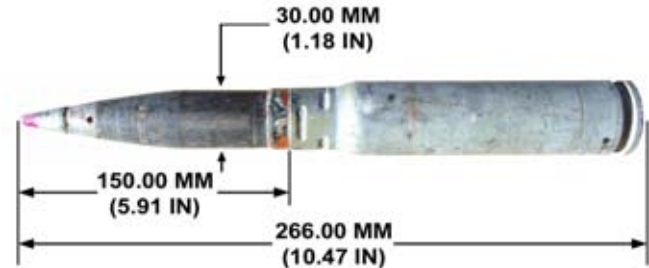

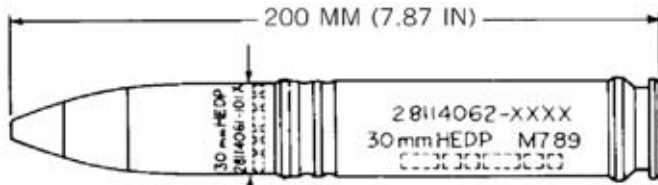

### U.S. CARTRIDGE, 30-MM, HEDP, M789

Ordnance used with:  
M789, 30-MM, HEDP  
M759, PROJECTILE, GRAZE-SENTITIVE PD  
PA520, ELEC. PRIMER

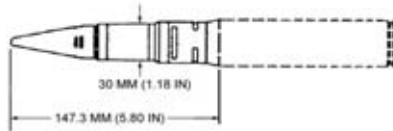

### U.S.S.R. PROJECTILE, 30-MM, AP-T, BT-30

Ordnance used with:  
BT-30, 30MM X 165MM, CARTRIDGE, AP-T





## U.S.S.R. PROJECTILE, 30-MM, APHEI, OFT WITH BD-30 FUZE

Ordnance used with:  
BD-30, PROJECTILE, BD  
CARTRIDGE, 30MM X 156B, BR-30, APHEI

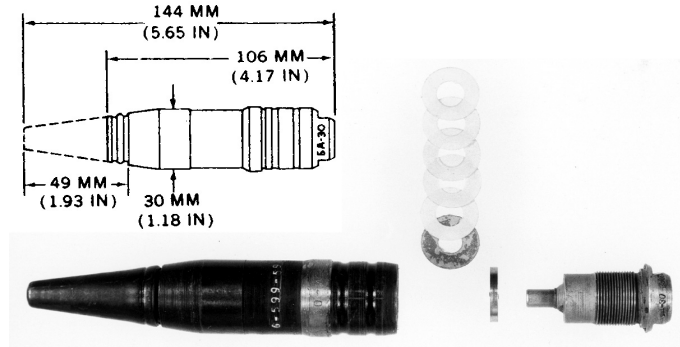

N.E.W. 16.00 G

## U.S.S.R. PROJECTILE, 30-MM, APHEI, OFT WITH BDM-30 FUZE

Ordnance used with:  
BDM-30, PROJECTILE, BD  
OFT, CARTRIDGE, 30-MM, APHEI (CURRENT)

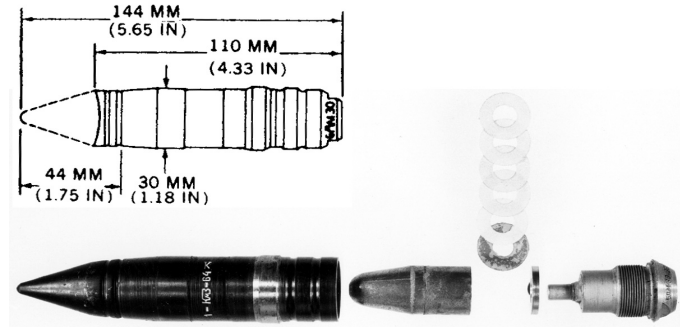

N.E.W. 26.00 G

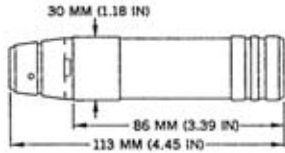

## U.S.S.R. PROJECTILE, 30-MM, FRAG, VOG-17M

Ordnance used with:  
VMG, PROJECTILE, PD  
7P9M, CARTRIDGE, 30MM, FRAG  
VOG-17M, CARTRIDGE, 30MM, FRAG  
VMG-M, PROJECTILE, PDS

N.E.W. 33.23 G

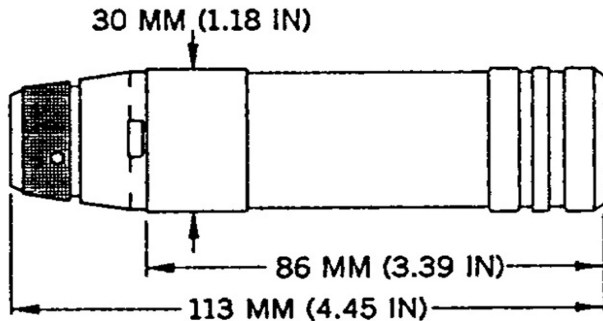

## U.S.S.R. PROJECTILE, 30-MM, FRAG, VOG-26

Ordnance used with:  
VOG-26, 30-MM, CARTRIDGE, FRAG  
VMG, PROJECTILE, PD  
VMG-M, PROJECTILE, PDS

N.E.W. 33.00 G

## U.S.S.R. PROJECTILE, 30-MM, FRAG-HEI, MODEL UNKNOWN

Ordnance used with:

A-670M, PROJECTILE, PDS

A670M, PROJECTILE, PDS

MG-32, PROJECTILE, PDS

MG32, PROJECTILE, PDS

OFZ, 30MM X 165MM, CARTRIDGE, HEI

UOF-84, 30MM X 165MM, CARTRIDGE, HEI

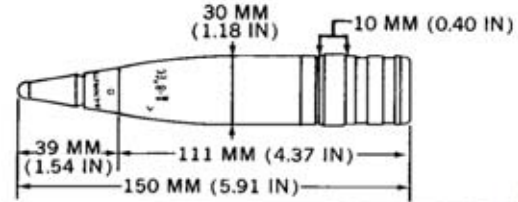

## U.S.S.R. PROJECTILE, 30-MM, FRAG-HEI, OFZ

Ordnance used with:

A-30, PROJECTILE, PD

B-30, PROJECTILE, PDS

A-30U, PROJECTILE, PD

OFZ, 30-MM, CARTRIDGE, HEI

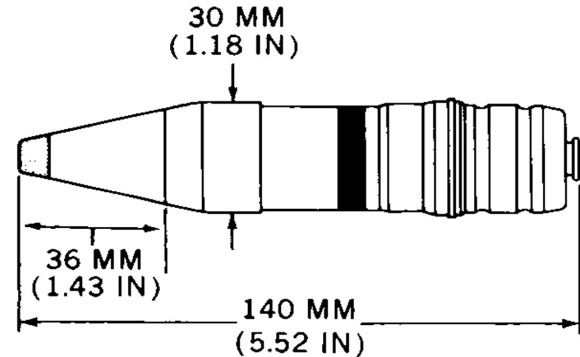

N.E.W. 47.00 G

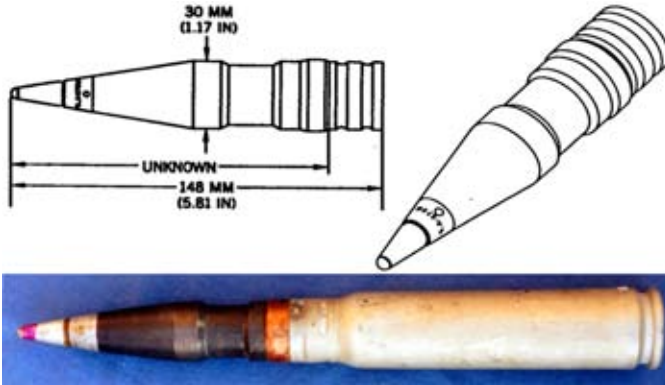

## U.S.S.R. PROJECTILE, 30-MM, HEI-T, OT

Ordnance used with:  
 A-670M, PROJECTILE, PDS  
 A670M, PROJECTILE, PDS  
 MG-32, PROJECTILE, PDS  
 MG32, PROJECTILE, PDS  
 FT, 30-MM, CARTRIDGE, HE-T  
 OT, 30-MM, CARTRIDGE, HE-T  
 OT-30, 30-MM, CARTRIDGE, HE-T  
 N.E.W. 38.00 G

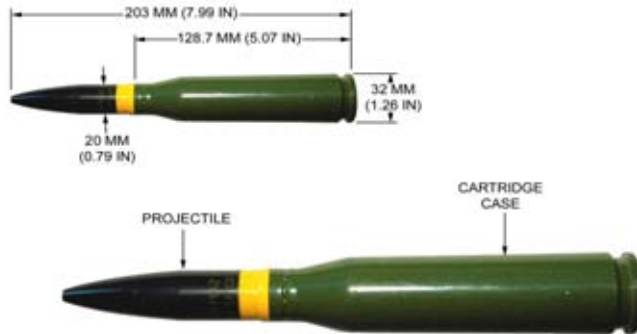

## ITALIAN CARTRIDGE, 20-MM, SAPHEI, MODEL UNKNOWN

Ordnance used with:  
 UNKNOWN, 20MM, SAPHEI  
 UNKNOWN, PROJECTILE, BDS

## U.S.S.R. CARTRIDGE, 30-MM, FRAG, VOG-17M (7P9M)

Ordnance used with:  
VMG, PROJECTILE, PD  
VMG-M, PROJECTILE, PSD  
7P9M, 30-MM, FRAGMENTATION  
VOG-17M, 30-MM, FRAGMENTATION

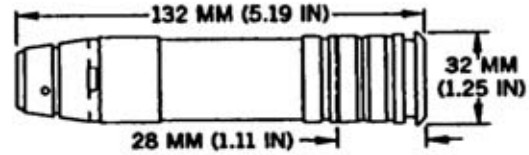

## U.S.S.R. CARTRIDGE, 30-MM, FRAG, VOG-26

Ordnance used with:  
VMG, PROJECTILE, PD  
VMG-M, PROJECTILE, PSD  
VOG-26, 30-MM, FRAGMENTATION

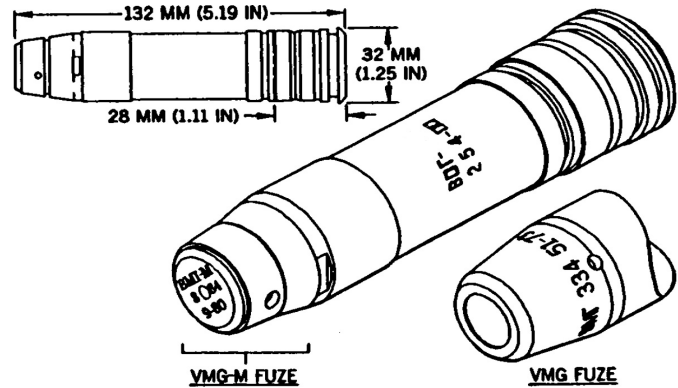



## BULGARIAN CARTRIDGE, 23MM, HEI-T, OFZT

Ordnance used with:  
 OFZT, 23MM, HEI-T  
 MG-25, PROJECTILE, PDS

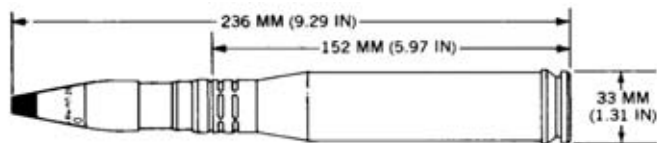

## U.S.S.R. CARTRIDGE, 23-MM, FRAG-HEIT, OFZT

Ordnance used with:  
 MG-25, FUZE, PROJECTILE, PDS  
 OFZT, 23MM, FRAG-HEIT  
 OFZT, 23-MM, HEI-T  
 ZUR-23-2S, GUN/MISSILE AIR DEFENSE SYSTEM, 23...  
 ZU-23, AIR DEFENSE GUN, 23MM, TWIN, TOWED  
 ZSU-23-4, AIR DEFENSE GUN, 23MM, QUAD, SELF-P...  
 SKYWIFE, AIR DEFENSE GUN, 23MM, TWIN, TOWED

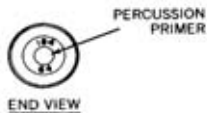

## U.S.S.R. CARTRIDGE, 23-MM, HEI-FRAG, OFZ

Ordnance used with:  
V-19U, PROJECTILE, PDSD  
OFZ, 23-MM, HEI  
V19UK, PROJECTILE, PDSD  
ZU-23, AIR DEFENSE GUN, 23MM, TWIN, TOWED  
ZSU-23-4, AIR DEFENSE GUN, 23MM, QUAD, SELF-P...  
SKYWIPE, AIR DEFENSE GUN, 23MM, TWIN, TOWED

N.E.W. 103.00 G

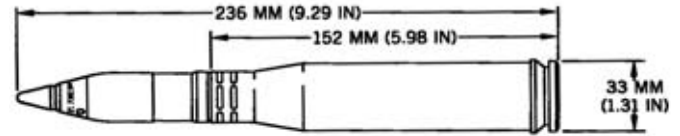

## GERMAN (FEDERAL REPUBLIC), CARTRIDGE, 27-MM X 145, HEI, DM21

Ordnance used with:  
DM 351, PROJECTILE, PDSD  
DM 341, PROJECTILE, PD  
DM 21, 27MM, HEI  
DM 401, PROJECTILE, PD

N.E.W. 108.00 G

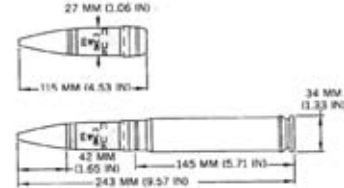

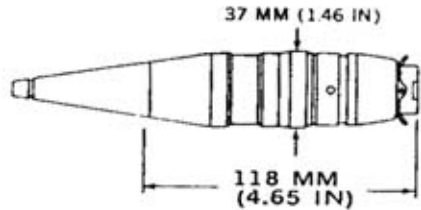

## U.S.S.R. CARTRIDGE, 37-MM, HEI-T, OZT

Ordnance used with:  
A-37U, PROJECTILE, PSDS  
OZT, 37 MM, HEIT

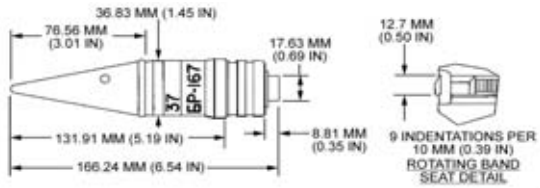

## U.S.S.R. PROJECTILE, 37-MM, AP-T, BR-167

Ordnance used with:  
UBR-167, 37-MM, CARTRIDGE, AP-T (253RMM)

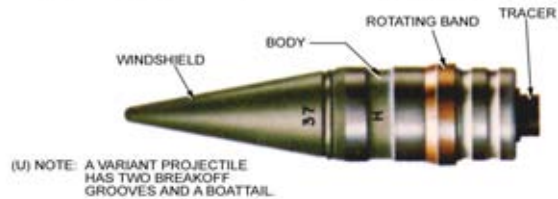

N.E.W. 12.25 G



## U.S.S.R. PROJECTILE, 37-MM, AP-T, TYPE BZT

Ordnance used with:  
BZT, 37MM, CARTRIDGE, AP-T



## U.S.S.R. PROJECTILE, 37-MM, FRAG-T, OR-167N

Ordnance used with:  
B-37, PROJECTILE, PDS  
MG-37, PROJECTILE, PDS  
MG-8, PROJECTILE, PDS  
UOR-167N, 37-MM X 253RMM, CARTRIDGE, FRAG-T  
UOR-167N, 37-MM, CARTRIDGE, FRAG-T

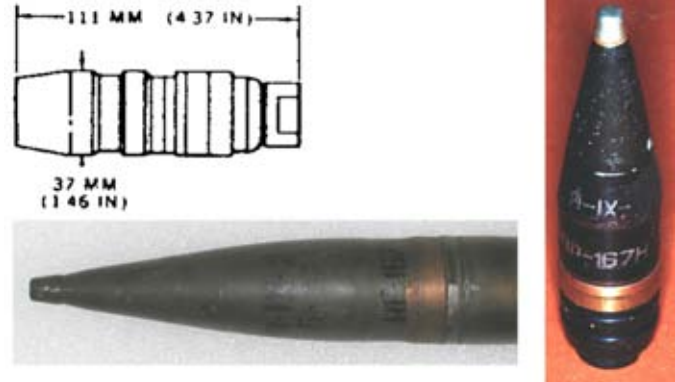

N.E.W. 35.00 G

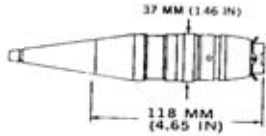

## U.S.S.R. PROJECTILE, 37-MM, HEI-T, OZT

Ordnance used with:  
A-37, PROJECTILE, PDS  
A-37U, PROJECTILE, PDS  
OZT, 37MM, CARTRIDGE, HEIT



N.E.W. 37.00 G

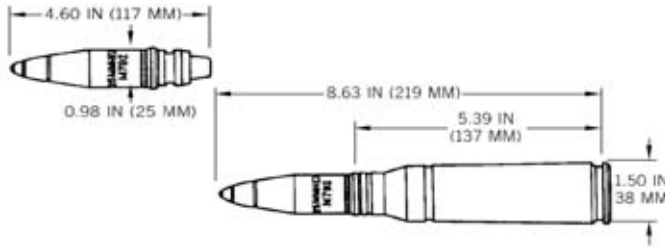

## U.S. CARTRIDGE, 25-MM, HEI-T, M792

Ordnance used with:  
M758, FUZE, PROJECTILE, PDSQ  
M758A1, FUZE, PROJECTILE, PDS  
M792, 25-MM, HEI-T



N.E.W. 92.00 G

## U.S.S.R. PROJECTILE, 100-MM, APFSDS-T, BM-2

Ordnance used with:  
UBM-2, CARTRIDGE, 100-MM, APFSDS

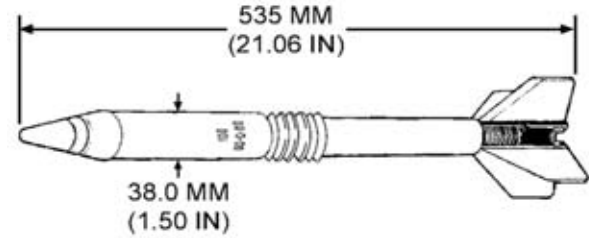

---

## U.S.S.R. PROJECTILE, 100-MM, APFSDS-T, BM-20

Ordnance used with:  
UBM-8, CARTRIDGE, 100-MM, APFSDS

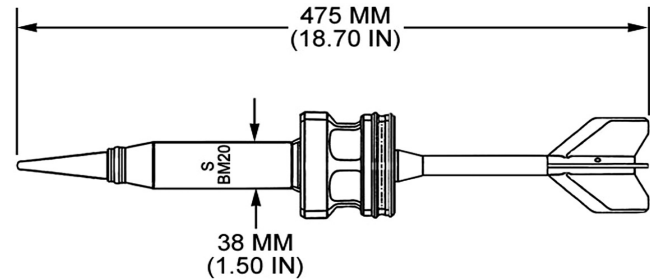

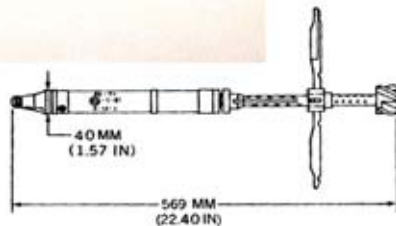

## BULGARIAN PROJECTILE, 40-MM, HE, OG-7V

Ordnance used with:

M-6

M6, PROJECTILE, PD

GO-2, PROJECTILE, PD

O-4M, PROJECTILE, PD

PG-7P, EJECTION CHARGE FOR PG-7-SERIES ROCKETS

OG-7V, 40MM, FRAG

N.E.W. 340.50 G



## CHINESE PROPELLING CHARGE, PG-2

Ordnance used with:

TYPE 56, 80MM, HEAT, (VARIANT 3)

TYPE 56, 80MM, HEAT, MODIFIED

PG-2, 80MM, HEAT

TYPE 56, 80MM, HEAT

RPG-2, LNCHR.

TYPE 56, LNCHR.

TYPE 56, 80MM, HEAT, (VARIANT 1)

N.E.W. 154.00 G

## RUSSIAN CARTRIDGE, 30-MM, AP-T, BT-30

Ordnance used with:  
BT-30, 30MM, AP-T

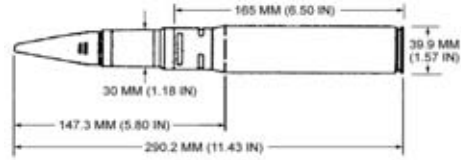

## U.S. CARTRIDGE, 40-MM, HEDP, M433

Ordnance used with:  
M550, PROJECTILE, PIBD  
M9, PROPELLING CHARGE  
M42, PERCUSSION PRIMER  
M118, CARTRIDGE CASE, 40 MM  
M433, 40 MM, HEDP

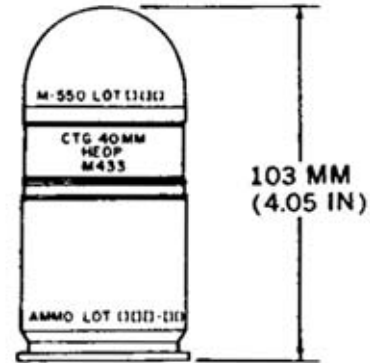

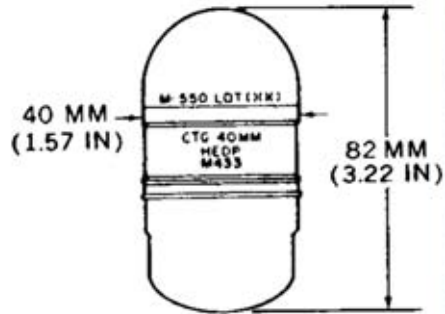

### U.S. PROJECTILE, 40-MM, HEDP, M433

Ordnance used with:  
M433, 40MM, CARTRIDGE, HEDP  
M550, PROJECTILE, PIBD

N.E.W. 43.00 G

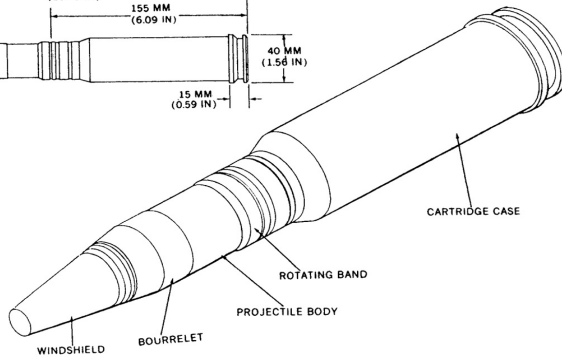
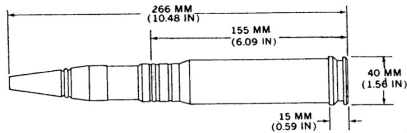

### U.S.S.R. CARTRIDGE, 30-MM, APHEI, OFT WITH BD-30 FUZE

Ordnance used with:  
OFT, 30MM, APHEI (EARLY)  
BD-30, PROJECTILE, BD

N.E.W. 134.00 G

## U.S.S.R. CARTRIDGE, 30-MM, APHEI, OFT WITH BDM-30 FUZE

Ordnance used with:  
BDM-30, PROJECTILE, BD  
OFT, 30MM, APHEI (EARLY)  
BR-30, TYPE II, 30-MM, APHEI  
OFT, 30MM, APHEI (CURRENT)  
BD-30, PROJECTILE, BD

N.E.W. 134.00 G

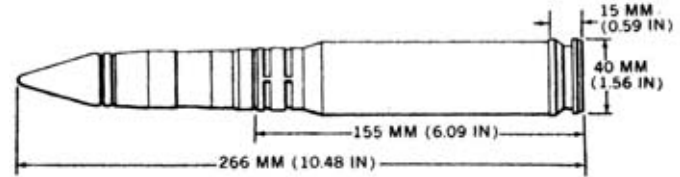

## U.S.S.R. CARTRIDGE, 30-MM, FRAG-HEI, MODEL UNKNOWN

Ordnance used with:  
A-670M, PROJECTILE, PDSD  
A670M, PROJECTILE, PDSD  
MG-32, PROJECTILE, PDSD  
MG32, PROJECTILE, PDSD  
OF-84, 30MM, HEI  
OFZ, 30MM, HEI

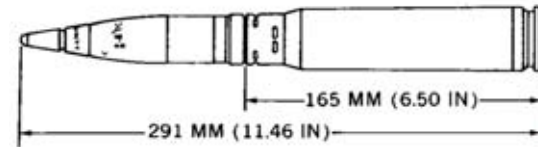

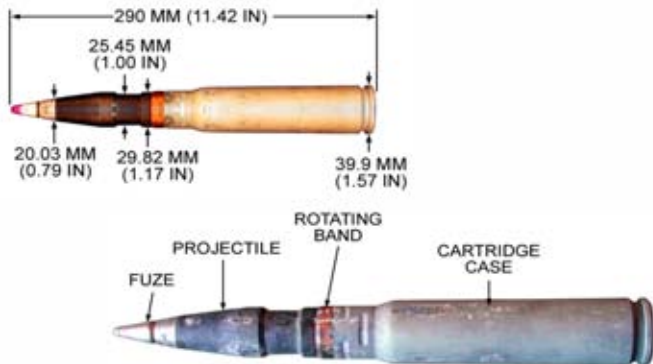

## U.S.S.R. CARTRIDGE, 30-MM, HE-T, OT

Ordnance used with:  
FT, 30-MM, HE-T  
OR-84, 30MM, HE-T  
OT, 30-MM, HE-T  
OT-30, 30-MM, HE-T  
A-670M, PROJECTILE, PDS  
A670M, PROJECTILE, PDS  
MG-32, PROJECTILE, PDS



## U.S.S.R. PROJECTILE, 40-MM, FRAG, BOUNDING, VOG-25

Ordnance used with:  
VMG-M, PROJECTILE, PDS



## RUSSIAN CARTRIDGE, 30-MM X 165B, APHE, BR-30

Ordnance used with:  
BR-30, 30-MM, APHE

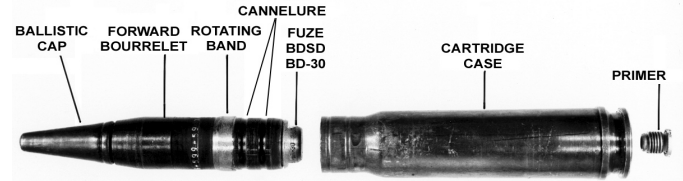

N.E.W. 358.00 G

## U.S.S.R. PROJECTILE, 40-MM, FRAG, BOUNDING, VOG-25P

Ordnance used with:  
BG-15  
GP-25  
GP-30  
GP-95  
GP-97





NOTE: BODY MAY BE PAINTED BROWN WITH A 7 MM RED STRIPE ADJACENT TO THE FUZE WELL AND A 12 MM GREEN STRIPE NEAR THE BASE OF THE PROJECTILE.

## U.K. PROJECTILE, 2-INCH, HE, MORTAR, MK 1

Ordnance used with:  
 NO. 161 MKS 3/2, PD, PROJECTILE  
 NO. 161 MK 4, PD, PROJECTILE  
 NO. 162 MK 1/1, PROJECTILE, PD



## U.S.S.R. CARTRIDGE, 37-MM, AP-T, UBR-167

Ordnance used with:  
 BR-167, 37-MM, AP-T  
 M1939, AIR DEFENSE GUN, 37MM, TOWED

## U.S.S.R. CARTRIDGE, 37-MM, FRAG-T, UOR-167N

Ordnance used with:  
B-37, PROJECTILE, PDS  
MG-37, PROJECTILE, PDS  
MG-8, PROJECTILE, PDS  
OR-167N, 37-MM, FRAG-T  
M1939, AIR DEFENSE GUN, 37MM, TOWED

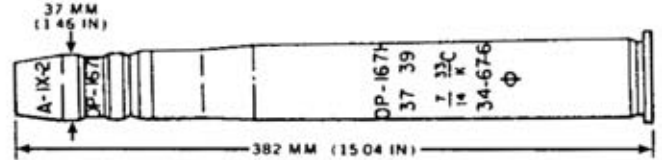

## U.S.S.R. PROJECTILE, 57 MM, APHE-T, BR-271M

Ordnance used with:  
MD-10, PROJECTILE, BD

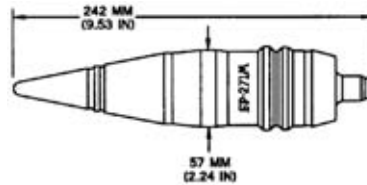

N.E.W. 13.00 G

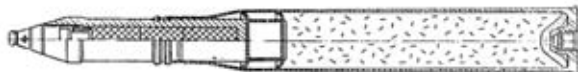
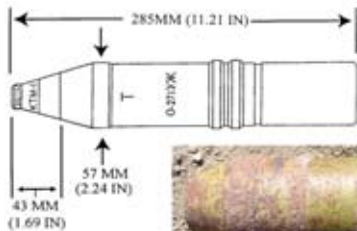

## U.S.S.R. PROJECTILE, 57 MM, FRAG, O-271UZH W/ CARTRIDGE, UO-271UZH

Ordnance used with:  
KTM-1U, PROJECTILE, PD  
KTM-1Y, PROJECTILE, PD  
O-271UZH, 57MM, HE  
UO-271UZH, 57MM, CARTRIDGE, HE

N.E.W. 200.00 G

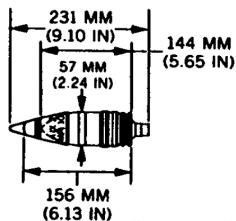

## U.S.S.R. PROJECTILE, 57-MM, APHE-T, BR-281

Ordnance used with:  
UBR-281, 57-MM, CARTRIDGE, APHE-T (57MM X 348MM)  
MD-10, PROJECTILE, BD

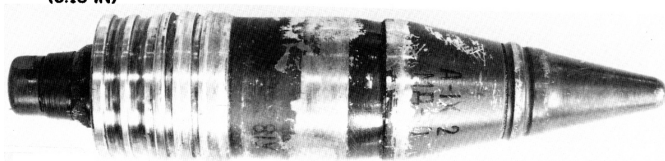

N.E.W. 18.00 G

## U.S.S.R. PROJECTILE, 57-MM, APHE-T, BR-281U

Ordnance used with:  
UBR-281U, 57-MM, CART, APHE-T (57MM X 348MM)  
MD-10, PROJECTILE, BD

N.E.W. 18.00 G



## U.S.S.R. PROJECTILE, 57-MM, FRAG-T, OR-281U

Ordnance used with:  
MG-57, PROJECTILE, PDS  
MGZ-57, PROJECTILE, PDS  
UOR-281U, CARTRIDGE, 57MM X 348MM, FRAG-T  
57-7N, PROJECTILE, PDS

N.E.W. 154.00 G

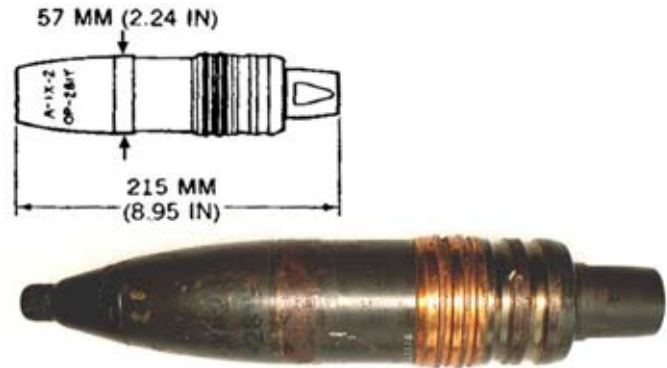

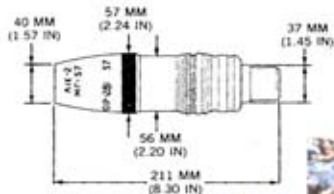

## U.S.S.R. PROJECTILE, 57-MM, HE, FRAG-T, OR-281

Ordnance used with:  
MG-57, PROJECTILE, PSD  
MGZ-57, PROJECTILE, PSD  
UOR-281, CARTRIDGE, 57MM X 348MM, FRAG-T



## CANADIAN CARTRIDGE, 60-MM, SMOKE, WP, MORTAR, C157

Ordnance used with:  
M935, PROJECTILE, PD  
XM935, PROJECTILE, PD  
C157, 60-MM, SMOKE, WP, MORTAR

## CHINESE CARTRIDGE, 60-MM, HE, MORTAR, M-83A

Ordnance used with:  
MP-1B, PROJECTILE, PD  
MP1B, PROJECTILE, PD  
83A  
M-83A, 60 MM, MORTAR, HE  
M38  
M83A  
TYPE 63



## CHINESE PROJECTILE, 60-MM, HE, MORTAR, M-83A

Ordnance used with:  
MP-1B, PROJECTILE, PD  
MP1B, PROJECTILE, PD  
M38, PROJECTILE, PD  
MP-1A, PROJECTILE, PD  
MP1A, PROJECTILE, PD  
UZRGM, GRENADE, STRIKER-RELEASE  
MP-1, PROJECTILE, PD  
N.E.W. 112.00 G

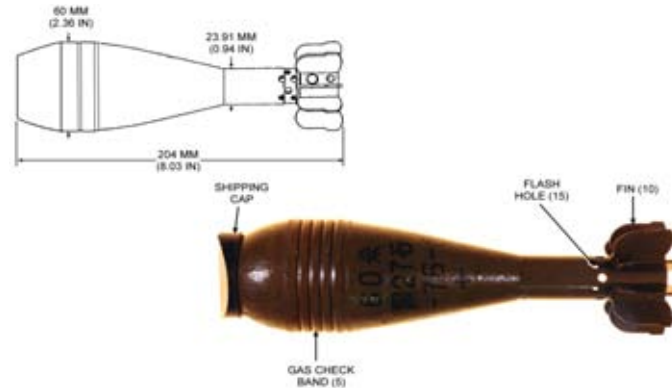

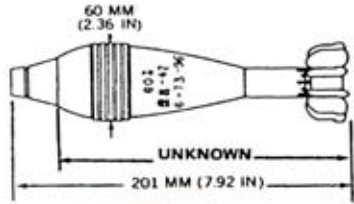

### CHINESE PROJECTILE, 60-MM, MORTAR, HE, MODEL UNKNOWN

Ordnance used with:  
 MP-1B, PROJECTILE, PD  
 MP1B, PROJECTILE, PD  
 M38, PROJECTILE, PD  
 MP-1A, PROJECTILE, PD  
 MP1A, PROJECTILE, PD  
 MP-1, PROJECTILE, PD  
 MP1, PROJECTILE, PD

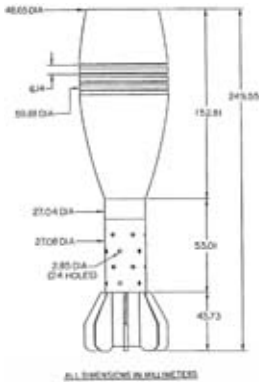

### IRANIAN PROJECTILE, 60-MM, MORTAR, HE, MODEL UNKNOWN

Ordnance used with:  
 M-6  
 M6, PROJECTILE, PD  
 MP-1B, PROJECTILE, PD  
 MP1B, PROJECTILE, PD  
 DM 111, PROJECTILE, PD  
 AZ DM111A1, PROJECTILE, PD  
 DM 111A1, PROJECTILE, PD  
 N.E.W. 196.00 G



## U.S. CARTRIDGE, 40-MM, HEI, PGU-9/B

Ordnance used with:  
MK 27 MOD 1, PROJECTILE, PD  
PGU-9/B, PROJECTILE, 40-MM, HEI

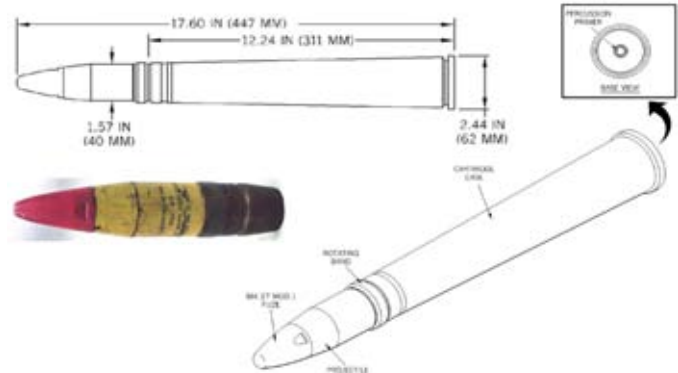

N.E.W. 380.00 G

## GERMAN PROJECTILES, 67-MM, HEAT AND APERS (ARMBRUST)

Ordnance used with:  
ARMBRUST, 67MM, CARTRIDGE, HEAT & APERS

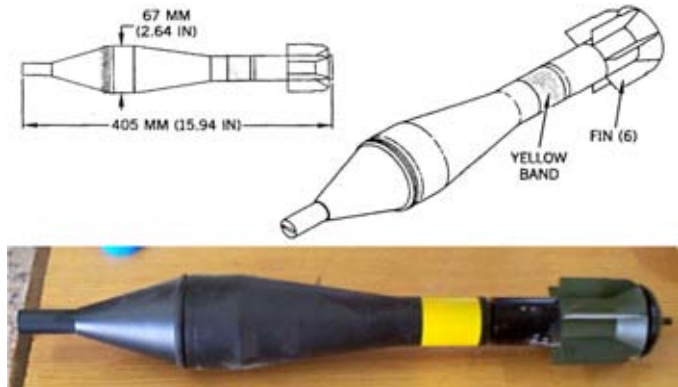

N.E.W. 169.00 G

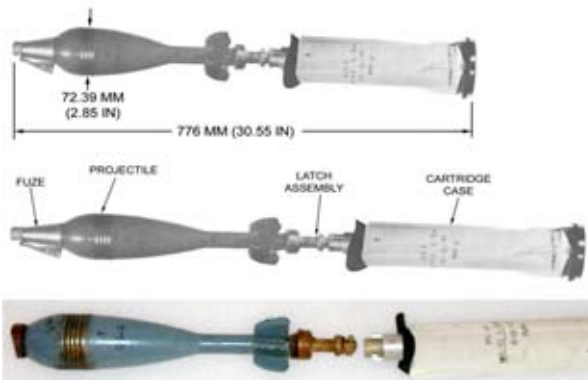

## ROMANIAN CARTRIDGE, 73-MM, HE, 346-E (TEARDROP, OG-9)

Ordnance used with:

346-E, 73MM, HE (TEARDROP)  
 346E, 73MM, HE (TEARDROP)  
 OG-9, 73MM, HE (TEARDROP)  
 OG-9/F, 73MM, HE (TEARDROP)  
 346-E, PROJECTILE, PD  
 UB-2M, PROJECTILE, PD  
 UB2, PROJECTILE, PD



## ROMANIAN PROJECTILE, 73-MM, HE, 346-E

Ordnance used with:

346-E, PROJECTILE, PD  
 UB-2M, PROJECTILE, PD  
 UB2, PROJECTILE, PD  
 UB2M, PROJECTILE, PD  
 346-E, 73MM, CARTRIDGE, HE (TEARDROP)  
 346E, 73MM, CARTRIDGE, HE (TEARDROP)  
 OG-9, 73MM, CARTRIDGE, HE (TEARDROP)  
 N.E.W. 535.25 G

## BULGARIAN PROJECTILE, 73-MM, HE-FRAG, OG-9B

Ordnance used with:  
 GO-2, PROJECTILE , PD  
 O-4M, PROJECTILE, PD  
 OG-15VB, CARTRIDGE, 73 MM, HE  
 SPG-9, 73MM, RECOILESS RIFLE

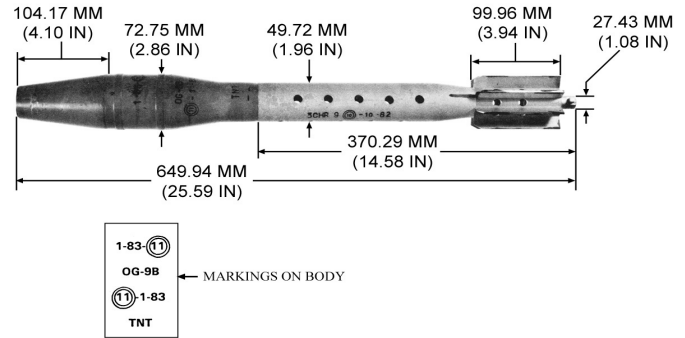

N.E.W. 371.95 G

## U.S.S.R. PROJECTILES, 73-MM, HE, FRAG, OG-9 & OG-9M

Ordnance used with:  
 GO-2, PROJECTILE , PD  
 UTIU M85, PROJECTILE, PD  
 O-4M, PROJECTILE, PD  
 OG-9P, 73MM, PROPELLING CHARGE  
 OG-15P, 73-MM, CARTRIDGE, HE  
 SPG-9, 73MM, RECOILESS RIFLE  
 OG-9V, 73MM, CARTRIDGE, FRAG

N.E.W. 704.82 G

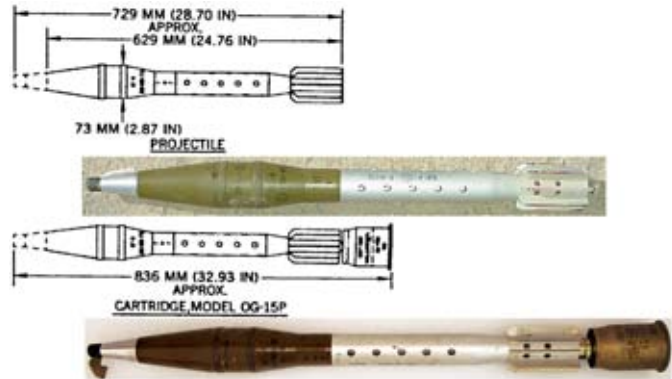



## CHINESE CARTRIDGE, 75-MM, HE, TYPE 52

Ordnance used with:  
 TYPE 1, PROJECTILE, PD (RR)  
 M30P-1  
 TYPE 6, PROJECTILE, PD  
 TYPE 52, 75 MM, HE, RR

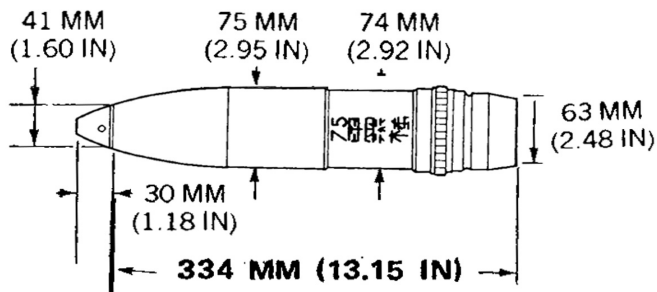

## CHINESE PROJECTILE, 75-MM, HEAT, TYPE UNKNOWN (COPY OF US M310A1)

Ordnance used with:  
 UNKNOWN, PROJECTILE, PIBD  
 TYPE 56, CARTRIDGE, 75MM, HEAT

N.E.W. 637.00 G

## CHINESE PROJECTILE, 75-MM, RR, HEAT, TYPE 52

Ordnance used with:  
TYPE 1 (SPECIAL), PROJECTILE, PIBD  
TS-1, PROJECTILE, PIBD  
TS-2, PROJECTILE, PIBD  
TYPE 1, PROJECTILE, PIBD  
TYPE 52, CARTRIDGE, 75MM, HEAT

N.E.W. 343.00 G

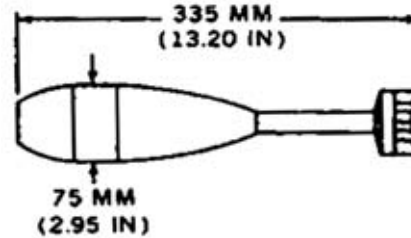

## GERMAN CARTRIDGES, 67-MM, HEAT AND APERS (ARMBRUST)

Ordnance used with:  
ARMBRUST, 67MM, HEAT  
ARMBRUST, 67MM, APERS  
ARMBRUST SC, 67MM, PRACTICE

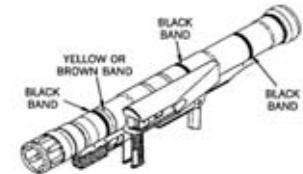
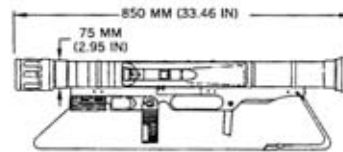



## CHINESE PROJECTILE, 75-MM, HE, TYPE 26.12

Ordnance used with:  
 TYPE 1, PROJECTILE, MORTAR, PD  
 TYPE 1 (ARTILLERY), PROJECTILE, PD  
 TYPE 1, PROJECTILE, PD (RR)  
 TYPE 3 (SPECIAL) (RECOILLESS RIFLE), PROJ, PD  
 TYPE 53, PROJECTILE, PD



## CHINESE PROJECTILE, 75-MM, HE, TYPE 52

Ordnance used with:  
 TYPE 1, PROJECTILE, PD (RR)  
 M30P-1  
 TYPE 6, PROJECTILE, PD  
 TYPE 52, CARTRIDGE, 75MM, HE

N.E.W. 0.71 KG

## U.K. CARTRIDGE, 3-INCH, HE, MORTAR, MK 2

Ordnance used with:  
NO. 162 /1, PROJECTILE, PD  
MK 2, 3-INCH, HE, MOTAR



---

## U.K. CARTRIDGE, 3-INCH, HE, MORTAR, MK 6

Ordnance used with:  
NO. 162 MK 1/2, PROJECTILE, PD



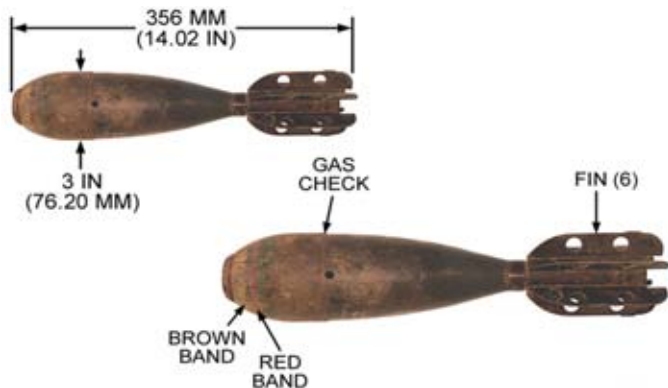

### U.K. PROJECTILE, 3-INCH, SMOKE (WP), MORTAR, MK 7

Ordnance used with:  
NO. 162 MK 1/2, PROJECTILE, PD  
NO. 162 MK 10, PROJECTILE, PD  
NO. 162 MK 3, PROJECTILE, PD  
NO. 162 MK 3/1, PROJECTILE, PD  
NO. 162 MK 3/2, PROJECTILE, PD  
NO. 162 MK 3/3, PROJECTILE, PD  
NO. 162 MK 4, PROJECTILE, PD



### U.K. PROJECTILE, 3-INCH, SMOKE (WP), MORTAR, MK II

Ordnance used with:  
NO. 162 MK 1/2, PROJECTILE, PD  
NO. 162 MK 10, PROJECTILE, PD  
NO. 162 MK 3, PROJECTILE, PD  
NO. 162 MK 3/1, PROJECTILE, PD  
NO. 162 MK 3/2, PROJECTILE, PD  
NO. 162 MK 3/3, PROJECTILE, PD  
NO. 162 MK 4, PROJECTILE, PD



## U.K. PROJECTILE, 3-INCH, SMOKE, MORTAR, MK 5

Ordnance used with:  
NO. 390 MK 5, TIME



---

## U.S.S.R. CARTRIDGE, 76-MM, FRAG-HE, UOF-353M

Ordnance used with:  
KTM-1, PROJECTILE, PD  
OF-350, 76-MM, HE-FRAG  
M1942 (ZIS-3), FIELD GUN, 76MM



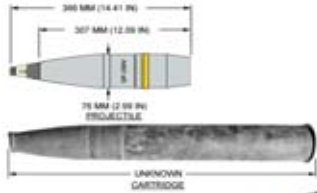

### U.S.S.R. CARTRIDGE, 76-MM, HE, UOF-15

Ordnance used with:  
RGM-2M, PROJECTILE, PD  
OF-350V, 76-MM, HE

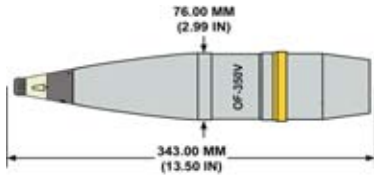

### U.S.S.R. PROJECTILE, 76-MM, FRAG-HE, OF-350V

Ordnance used with:  
RGM-2M, PROJECTILE, PD  
UOF-15, 76-MM, CARTRIDGE, HE



N.E.W. 604.00 G

## U.S.S.R. PROJECTILE, 76-MM, HE, FRAG, OF-350

Ordnance used with:

NSC-1, PROJECTILE, PDSD  
KT-1, FUZE, PROJECTILE, PD  
KT-2, FUZE, PROJECTILE, PD  
KT-3, FUZE, PROJECTILE, PD  
KTM-1, PROJECTILE, PD  
KTM-1U, PROJECTILE, PD  
KTM-1Y, PROJECTILE, PD

N.E.W. 713.00 G

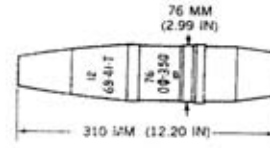

## U.S.S.R. PROJECTILE, 76-MM, HE, FRAG, OF-350A

Ordnance used with:

3GT, FUZE, PROJECTILE, PD  
KT-1, FUZE, PROJECTILE, PD  
KT-2, FUZE, PROJECTILE, PD  
KT-3, FUZE, PROJECTILE, PD  
KTM-1, PROJECTILE, PD  
KTM-2, PROJECTILE, PD  
KTM-3, PROJECTILE, PD

N.E.W. 1.60 LB

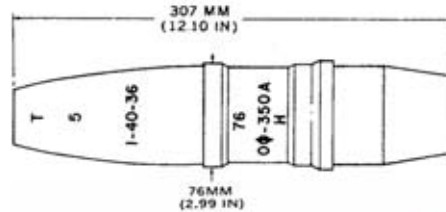

## U.S.S.R. PROJECTILE, 76-MM, HEAT-FS, BK-354M



Ordnance used with:  
GPV-2, PROJECTILE, PIBD, SPITBACK

N.E.W. 0.80 KG

## U.S.S.R. PROJECTILE, 76-MM, SMOKE, D-350

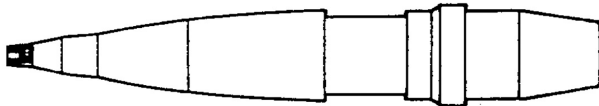
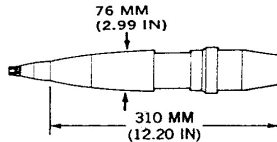

Ordnance used with:  
KT-1, FUZE, PROJECTILE, PD  
KT-2, FUZE, PROJECTILE, PD  
KT-3, FUZE, PROJECTILE, PD  
KTM-1, PROJECTILE, PD  
KTM-1U, PROJECTILE, PD  
KTM-1Y, PROJECTILE, PD  
KTM-2, PROJECTILE, PD

## CHINESE PROJECTILE, 80-MM, HEAT, TYPE 56 (VARIANT 1)

Ordnance used with:  
DK-2, PROJECTILE, BD  
TYPE 4, PROJECTILE, BD  
RPG-2, LNCHR.  
TYPE 56, LNCHR.  
PG-2, PROPELLING CHARGE



---

## CHINESE PROJECTILE, 80-MM, HEAT, TYPE 56 (VARIANT 2)

Ordnance used with:  
DK-2, PROJECTILE, BD  
TYPE 4, PROJECTILE, BD  
RPG-2, LNCHR.  
TYPE 56, LNCHR.  
PG-2, PROPELLING CHARGE



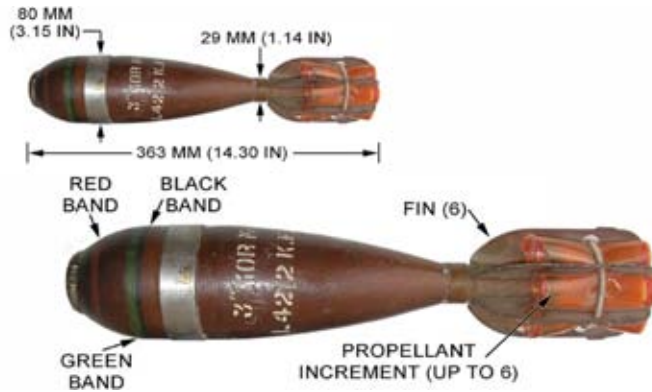

### U.K. PROJECTILE, 3-INCH, HE, MK 3

Ordnance used with:  
NO. 152 I, PROJECTILE, PD  
NO. 162 MK 2/1, PROJECTILE, PD



### U.K. PROJECTILE, 3-INCH, SMOKE (WP), MORTAR, MK 4

Ordnance used with:  
NO. 390 MK 2A, PROJECTILE, PTT

## AUSTRIAN CARTRIDGE, 81-MM, MORTAR, LONG DISTANCE, HE, HE 70LD

Ordnance used with:  
M525A1, PROJECTILE, PD  
M935, PROJECTILE, PD  
XM935, PROJECTILE, PD  
AZ 111 A2  
AZ DM 111A2, PD  
DM 111A2, PROJECTILE, PD  
DM 111A3, PROJECTILE, PD  
N.E.W. 748.00 G

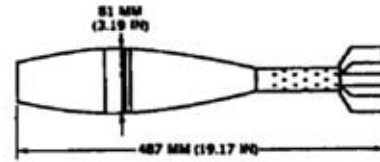

## CANADIAN PROJECTILE, 81-MM, ILLUMINATION, MORTAR, C105

Ordnance used with:  
DM 93-2, PROJECTILE, MT  
C105, CARTRIDGE, 81 MM, ILLUM, MORTAR



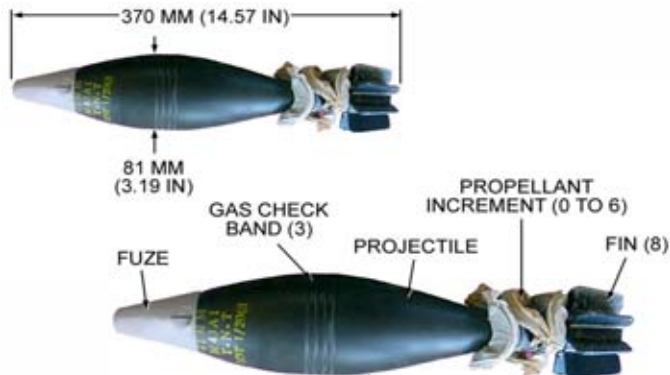

## IRANIAN CARTRIDGE, 81-MM, HE, MORTAR, M43A1

Ordnance used with:  
 AZ 111 A2  
 AZ DM 111A2, PD  
 DM 111A2, PROJECTILE, PD  
 AZ111 A2, PROJECTILE, PD  
 AZ111-A2  
 PAI-1A, PROJECTILE, PD  
 M43A1, 81MM, HE

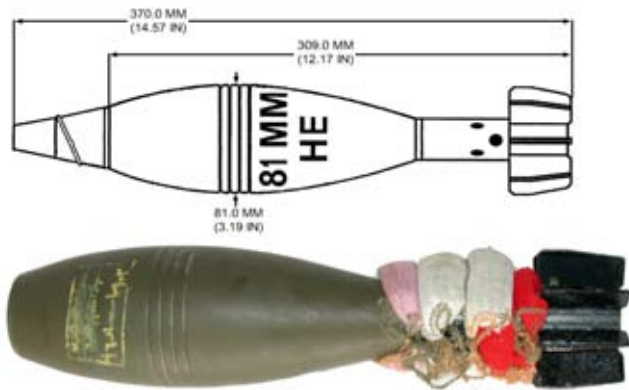

## IRANIAN CARTRIDGE, 81-MM, HE, MORTAR, MODEL UNKNOWN

Ordnance used with:  
 MP-5C  
 MP5C, PROJECTILE, PD  
 AZ111 A2, PROJECTILE, PD  
 AZ111-A2  
 MP-7A  
 MP7A, PROJECTILE, PD  
 MP-5B, PROJECTILE, PD  
 N.E.W. 550.00 G



## IRANIAN CARTRIDGE, HE, MORTAR, MODEL UNKNOWN

Ordnance used with:  
MP-7A  
MP7A, PROJECTILE, PD  
UNKNOWN, 81MM, HE, MORTAR



## IRANIAN PROJECTILE, 81-MM, HE, MORTAR, M43A1

Ordnance used with:  
AZ 111 A2  
AZ DM 111A2, PD  
DM 111A2, PROJECTILE, PD  
AZ111 A2, PROJECTILE, PD  
AZ111-A2  
M38, PROJECTILE, PD  
MP-1A, PROJECTILE, PD



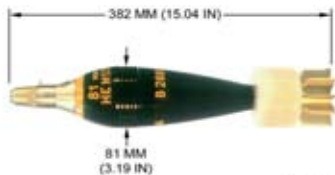

## PAKISTANI CARTRIDGE, 81-MM, HE, MORTAR, M57 DA-2

Ordnance used with:  
V19PA-A2, PROJECTILE, PD  
M57 DA-2, 81MM, MORTAR, HE  
V19PA, PROJECTILE, PD

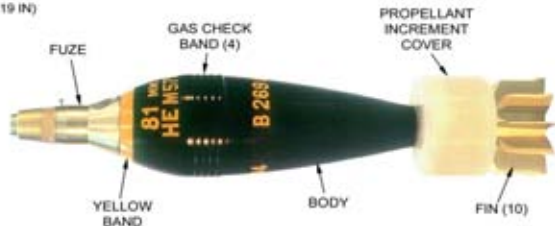

## PAKISTANI PROJECTILE, 81-MM, HE, MORTAR, M57 DA-2

Ordnance used with:  
PAI-1A, PROJECTILE, PD  
PAI1A  
V19PA-A2, PROJECTILE, PD  
M57 DA-2, 81-MM, CARTRIDGE, MORTAR, HE  
V19PA, PROJECTILE, PD



## U.S. CARTRIDGE, 81-MM, MORTAR, HE, M821

Ordnance used with:  
M567, PROJECTILE, PD  
XM567E5, PROJECTILE, PD  
M734 PROJECTILE, MULTIOPTION  
M935, PROJECTILE, PD  
XM935, PROJECTILE, PD

N.E.W. 726.00 G

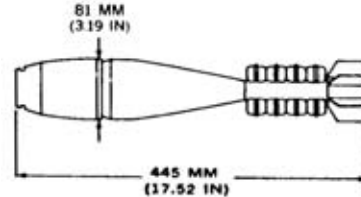

## U.S. PROJECTILE, 81-MM, ILLUMINATION, M853A1

Ordnance used with:  
M768 PROJECTILE, PTT  
M772 PROJECTILE, MTSQ  
M853A1, 81MM, ILLUM

N.E.W. 1.80 LB

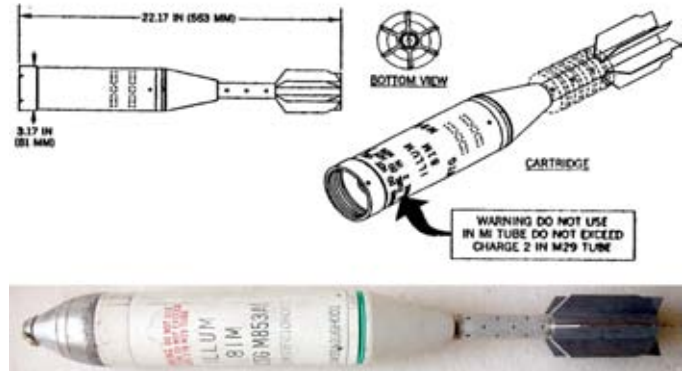

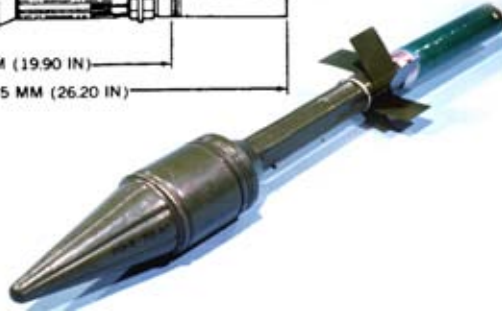
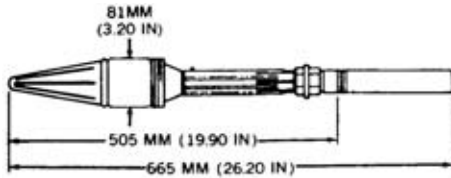

## U.S.S.R. CARTRIDGE, 80-MM, HEAT, PG-2; CHINESE CARTRIDGE, HEAT, TYPE 56

Ordnance used with:  
DK-4, PROJECTILE, BD  
DK-2, PROJECTILE, BD  
TYPE 4, PROJECTILE, BD  
RPG-2, LNCHR.  
TYPE 56, LNCHR.  
PG-2, PROPELLING CHARGE

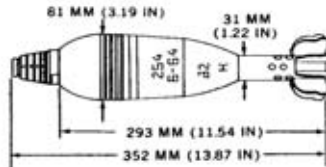

## U.S.S.R. PROJECTILE, 82-MM, ILLUM, S-832S

Ordnance used with:  
T-1, PROJECTILE, TSQ

## AUSTRIAN CARTRIDGE, 82-MM, HE, MORTAR, HE83 LD

Ordnance used with:  
PDM525, PROJECTILE, PD  
T37A1B1, PROJECTILE, PD  
HE 83 LD  
HE 83, 82-MM, MORTAR, HE  
HE83 LD, 82MM, HE  
M52B1, PROJECTILE, PD  
TP 70, IGNITER, MORTAR



## AUSTRIAN PROJECTILE, 82-MM, HE, MORTAR, HE83 LD

Ordnance used with:  
PDM525, PROJECTILE, PD  
T37A1B1, PROJECTILE, PD  
M52B1, PROJECTILE, PD  
HE 83 LD, CARTRIDGE, 82MM, HE

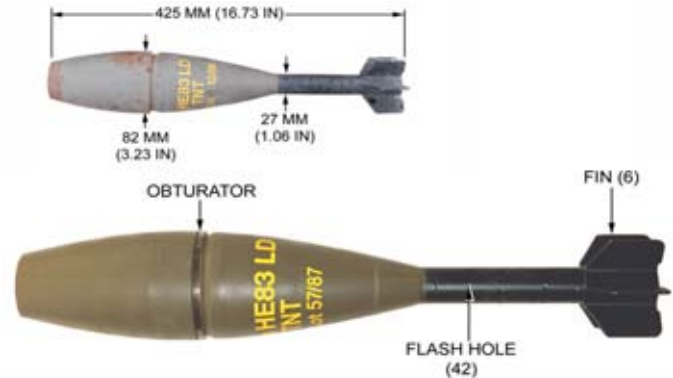

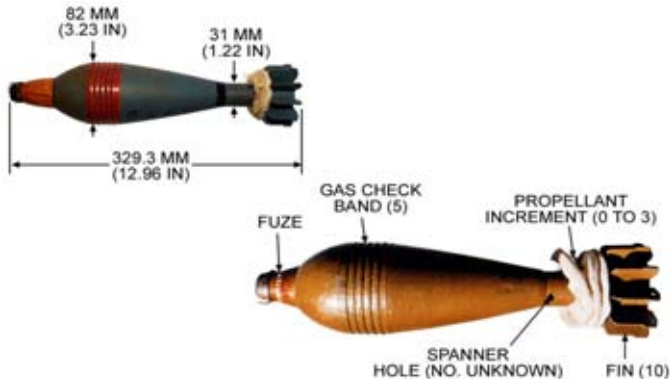

## CHINESE CARTRIDGE, 82-MM, HE, MORTAR, TYPE 53

Ordnance used with:  
 MP-1B, PROJECTILE, PD  
 MP1B, PROJECTILE, PD  
 M38, PROJECTILE, PD  
 MP-1A, PROJECTILE, PD  
 MP1A, PROJECTILE, PD  
 TH521, 82-MM, HE  
 TYPE 53, 82-MM, HE

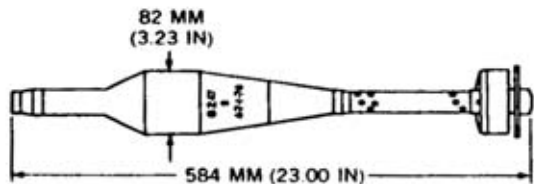

## CHINESE CARTRIDGE, 82-MM, HEAT, DK 82 (TYPE 65)

Ordnance used with:  
 TYPE 4, PROJECTILE, BD  
 DK 82, 82MM, HEAT  
 TYPE 65



N.E.W. 595.00 G

## CHINESE CARTRIDGE, 82MM, HEAT, TYPE 65 (VARIANT 2)

Ordnance used with:  
TYPE 65 (VARIANT 2), 82MM, HEAT

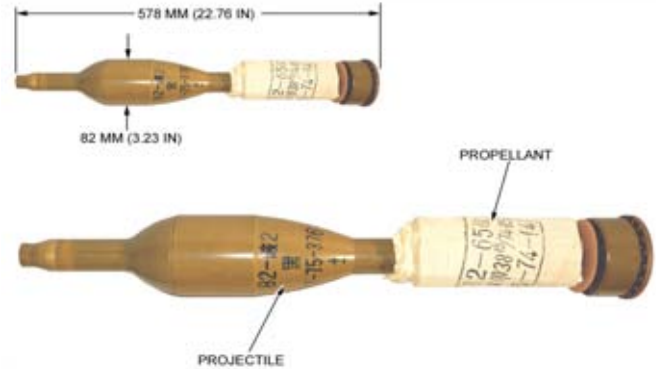

## CHINESE PROJECTILE, 82-MM, HE, MORTAR, 42-832

Ordnance used with:  
MM-6, PROJECTILE, PD



## CHINESE PROJECTILE, 82-MM, HE, MORTAR, M30

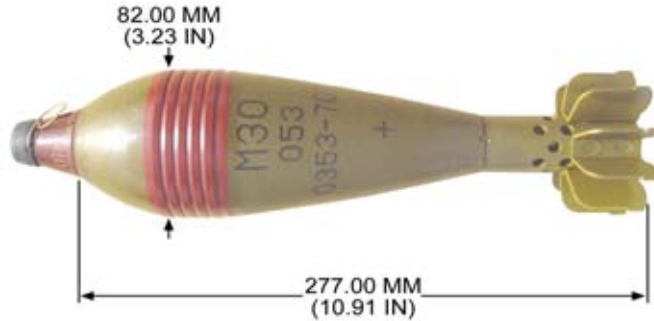

Ordnance used with:  
M-6, PROJECTILE, PD  
M30P-1  
TYPE 6, PROJECTILE, PD

## CHINESE PROJECTILE, 82-MM, HE, MORTAR, TYPE 53

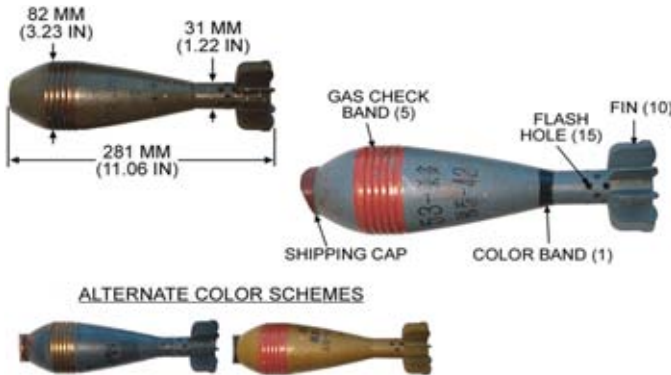

Ordnance used with:  
MP-1B, PROJECTILE, PD  
MP1B, PROJECTILE, PD  
M38, PROJECTILE, PD  
MP-1A, PROJECTILE, PD  
MP1A, PROJECTILE, PD  
TYPE UNIVERSAL MODIFIED, PD  
MP-1, PROJECTILE, PD  
N.E.W. 0.86 LB



## CHINESE PROJECTILE, 82-MM, HE-FRAG, (TYPE 64)

Ordnance used with:  
TYPE 2, PROJECTILE, PD  
TYPE 64, 82-MM, HE, FRAG, MORTAR, CARTRIDGE

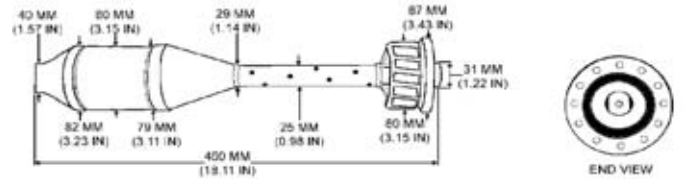

## CHINESE PROJECTILE, 82-MM, HEAT, DK-82 (TYPE 65)

Ordnance used with:  
DK 82, CARTRIDGE, 82MM, HEAT  
TYPE 65  
TYPE 4, PROJECTILE, BD

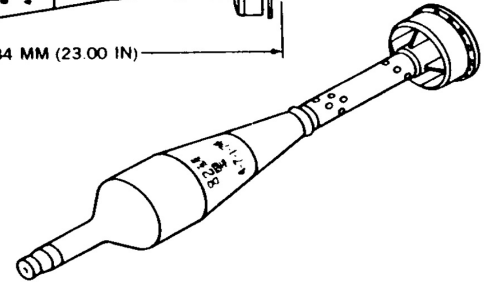
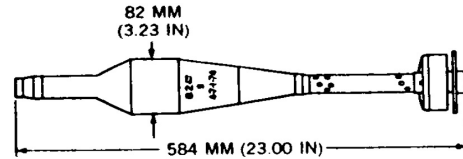

N.E.W. 428.00 G

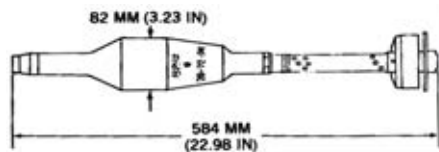

## CHINESE PROJECTILE, 82-MM, HEAT, DK-82 (TYPE 65/1) VARIANT

Ordnance used with:  
TYPE 4, PROJECTILE, BD

N.E.W. 595.00 G

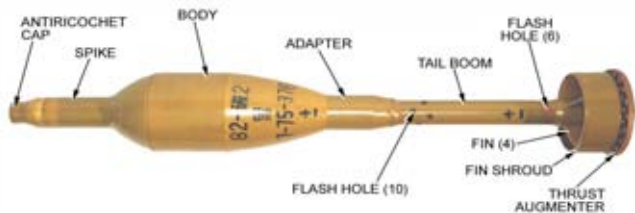

## CHINESE PROJECTILE, 82-MM, HEAT, TYPE 65 (VARIANT 2)

Ordnance used with:  
TYPE 4, PROJECTILE, BD  
TYPE 65 (VARIANT 2), CARTRIDGE, 82MM, HEAT

## CHINESE PROJECTILE, 82-MM, MORTAR, HE, MODEL UNKNOWN

Ordnance used with:  
MP-1B, PROJECTILE, PD  
MP1B, PROJECTILE, PD  
M38, PROJECTILE, PD  
MP-1A, PROJECTILE, PD  
MP1A, PROJECTILE, PD  
MP-1, PROJECTILE, PD  
MP1, PROJECTILE, PD  
N.E.W. 399.00 G

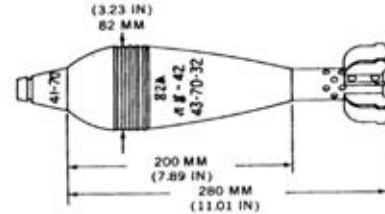

## CHINESE PROJECTILE, 82-MM, MORTAR, HE, MODEL UNKNOWN

Ordnance used with:  
M-6  
M6, PROJECTILE, PD  
PUI-1A, PROJECTILE, PD

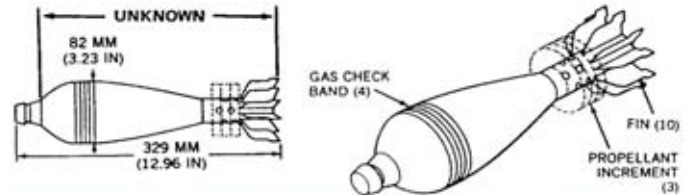



## NORTH KOREAN CARTRIDGE, 82-MM, FRAG, O-881

Ordnance used with:  
GK-1, FUZE, PROJECTILE, PD  
O-881, 82 MM, FRAG  
B-2, PROJECTILE, PD

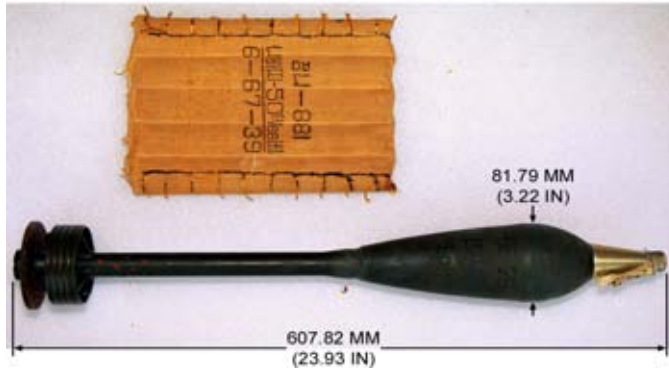

## NORTH KOREAN PROJECTILE, 82-MM, FRAG, O-881

Ordnance used with:  
GK-2, FUZE, PROJECTILE, PD  
O-881, CARTRIDGE, 82MM, FRAGMENTATION  
B-2, PROJECTILE, PD

N.E.W. 470.00 G

## PAKISTANI CARTRIDGE, 82-MM, HE, M-57D MK 1

Ordnance used with:  
PAI-1A, PROJECTILE, PD  
PAI1A  
V19PA-A2, PROJECTILE, PD  
PAI-1A, PROJECTILE, PD  
M-57D MK 1, 82MM, MORTAR, HE



## PAKISTANI PROJECTILE, 82-MM, HE, M-57D MK 1

Ordnance used with:  
PAI-1A, PROJECTILE, PD  
PAI1A  
V19PA-A2, PROJECTILE, PD  
PAI-1A, PROJECTILE, PD  
M-57D MK 1, CARTRIDGE, 82MM, MORTAR, HE



N.E.W. 681.00 G



**PAKISTANI PROJECTILE, 82-MM, HE, MORTAR,  
MODEL UNKNOWN**

Ordnance used with:  
PAI-1A, PROJECTILE, PD  
PAI1A



**SPANISH CARTRIDGE, 82-MM, SMOKE (WP),  
MORTAR, MODEL UNKNOWN**

Ordnance used with:  
EE-53-W-330  
EE53-W330, PROJECTILE, PD  
MDL. UNKNOWN, 82-MM, SMOKE, WP, MORTAR

## SPANISH PROJECTILE, 82-MM, MORTAR, WP, SMOKE, MODEL UNKNOWN

Ordnance used with:  
EE-53-W-330  
EE53-W330, PROJECTILE, PD  
MDL. UNKNOWN, 82-MM, SMOKE, WP, CARTRIDGE, MORTAR

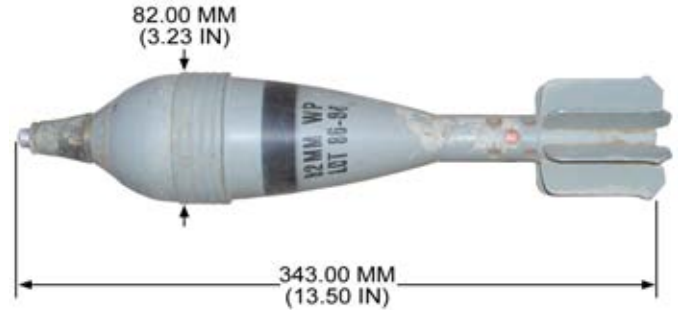

## U.S.S.R. CARTRIDGE, 82-MM, FRAG, MORTAR, UO-832 DU

Ordnance used with:  
SH-82, PROJECTILE, PD  
O-832DU, 82-MM, FRAG  
M-1, PROJECTILE, PDSQ  
TYPE 1, PROJECTILE, PD  
M-2, PROJECTILE, PD  
M-3, PROJECTILE, PD  
M-4, PROJECTILE, PD

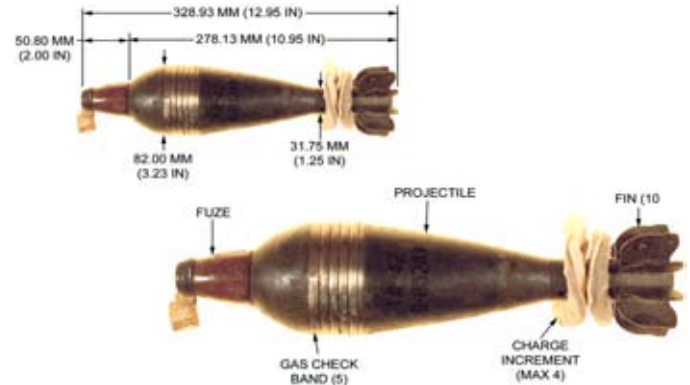

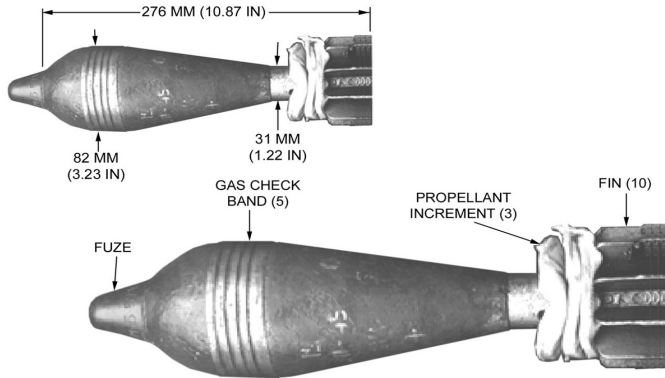

### U.S.S.R. CARTRIDGE, 82-MM, FRAG, MORTAR, UO-832D

Ordnance used with:  
 SH-82, PROJECTILE, PD  
 O-832D, 82-MM, MORTAR, FRAG  
 M-1, PROJECTILE, PDSQ  
 TYPE 1, PROJECTILE, PD  
 M-2, PROJECTILE, PD  
 M-3, PROJECTILE, PD  
 M-4, PROJECTILE, PD

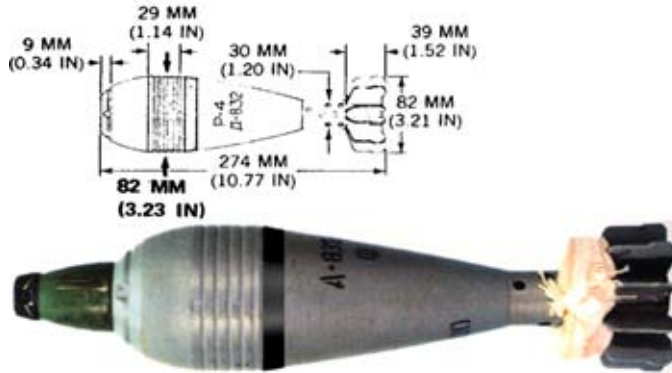

### U.S.S.R. CARTRIDGE, 82-MM, MORTAR, SMOKE, WP, D-832

Ordnance used with:  
 SH-82, PROJECTILE, PD  
 M-1, PROJECTILE, PDSQ  
 TYPE 1, PROJECTILE, PD  
 M-2, PROJECTILE, PD  
 M-3, PROJECTILE, PD  
 M-4, PROJECTILE, PD  
 M-5, PROJECTILE, PD



## U.S.S.R. CARTRIDGE, 82-MM, RECOILLESS, BK-881

Ordnance used with:  
GK-1, FUZE, PROJECTILE, PD  
GK-2, FUZE, PROJECTILE, PD  
GK-2M, FUZE, PROJECTILE, PD  
ZHN-881, 82MM, PROPELLING CHARGE

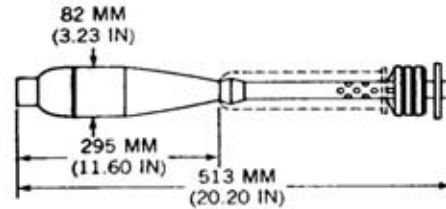

N.E.W. 1.36 KG

## U.S.S.R. PROJECTILE, 82-MM, MORTAR, FRAG, O-832-DU

Ordnance used with:  
SH-82, PROJECTILE, PD  
M-1, PROJECTILE, PDSQ  
TYPE 1, PROJECTILE, PD  
M-2, PROJECTILE, PD  
M-3, PROJECTILE, PD  
M-4, PROJECTILE, PD  
M-5, PROJECTILE, PD

N.E.W. 0.44 KG

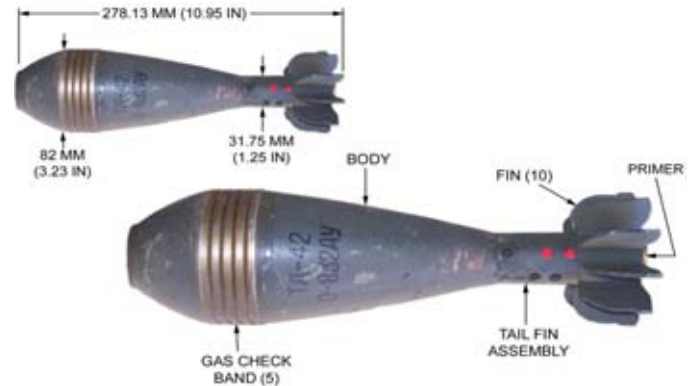

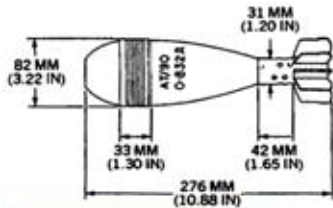

## U.S.S.R. PROJECTILE, 82-MM, MORTAR, FRAG, O-832D

Ordnance used with:  
 SH-82, PROJECTILE, PD  
 M-1, PROJECTILE, PDSQ  
 TYPE 1, PROJECTILE, PD  
 M-2, PROJECTILE, PD  
 M-3, PROJECTILE, PD  
 M-4, PROJECTILE, PD  
 M-5, PROJECTILE, PD  
 N.E.W. 0.41 KG

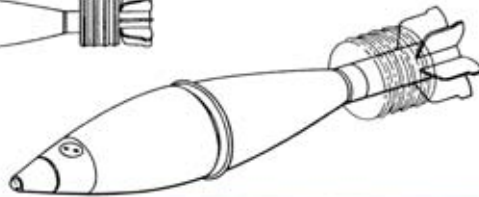
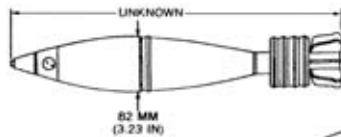

## YUGOSLAV CARTRIDGE, 82-MM, HE, MORTAR, M71

Ordnance used with:  
 UT M68 P1, PROJECTILE, PD  
 UT M68P1, PROJECTILE, PD  
 UT.M68 P1, PROJECTILE, PD  
 UTU M67, PROJECTILE, PD  
 M71, 82-MM, HE, MORTAR  
 UT M5P1, PROJECTILE, PD  
 UTM5P1, PROJECTILE, PD

## YUGOSLAV CARTRIDGE, 82-MM, HE, MORTAR, M74

Ordnance used with:  
UT M68 P1, PROJECTILE, PD  
UT M68P1, PROJECTILE, PD  
UT.M68 P1, PROJECTILE, PD  
M74, 82MM, HE, MORTAR  
M6-R, PROJECTILE, PD  
M-6R, PROJECTILE, PD

N.E.W. 680.00 G

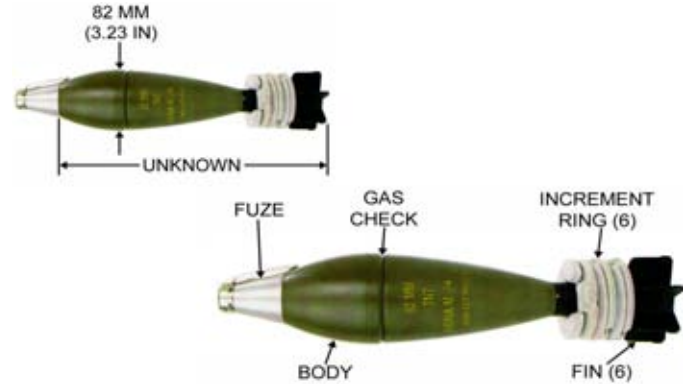

## YUGOSLAV CARTRIDGE, 82-MM, HE, MORTAR, M96

Ordnance used with:  
PDB 332, PROJECTILE, PD  
UTU M67, PROJECTILE, PD  
ER, 82MM, HE, MORTAR  
M96, 82-MM, HE, MORTAR  
UT M96, PROJECTILE, PD



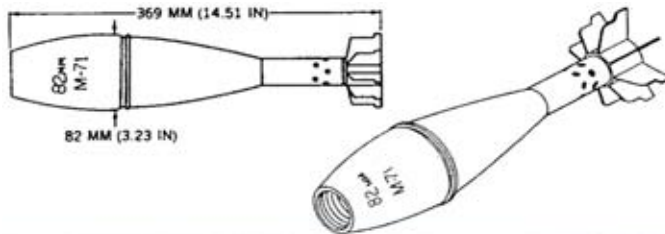

## YUGOSLAV PROJECTILE, 82-MM, HE, MORTAR, M71

Ordnance used with:

- UT M68 P1, PROJECTILE, PD
- UT M68P1, PROJECTILE, PD
- UT.M68 P1, PROJECTILE, PD
- UTU M67, PROJECTILE, PD
- UT M5P1, PROJECTILE, PD
- UTM5P1, PROJECTILE, PD
- M71, 82MM, CARTRIDGE, HE, MORTAR

N.E.W. 690.00 G

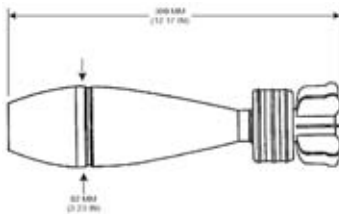

## YUGOSLAV PROJECTILE, 82-MM, HE, MORTAR, M74

Ordnance used with:

- UT M68 P1, PROJECTILE, PD
- UT M68P1, PROJECTILE, PD
- UT.M68 P1, PROJECTILE, PD
- UTU M67, PROJECTILE, PD
- M6-R, PROJECTILE, PD
- M-6R, PROJECTILE, PD
- M74, 82MM, CARTRIDGE, HE, MORTAR

N.E.W. 680.00 G



## YUGOSLAV PROJECTILE, 82-MM, HE, MORTAR, M96 (ER)

Ordnance used with:  
PDB 332, PROJECTILE, PD  
UTU M67, PROJECTILE, PD  
UT M96, PROJECTILE, PD  
ER, 82MM, CARTRIDGE, HE, MORTAR  
M96, 82MM, CARTRIDGE, HE, MORTAR

N.E.W. 860.00 G

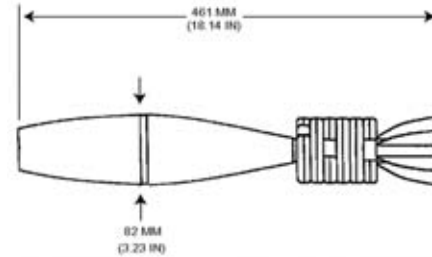

## YUGOSLAV PROJECTILE, 82-MM, MORTAR, SMOKE, M71

Ordnance used with:  
UT M70P1, PROJECTILE, PD  
UT,M70 P1, PROJECTILE, PD  
UTU M67, PROJECTILE, PD  
M71, 82-MM, CARTRIDGE, SMOKE, WP, MORTAR

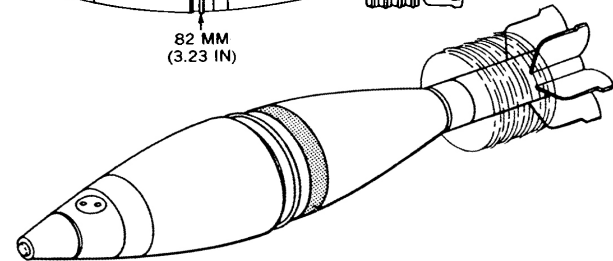
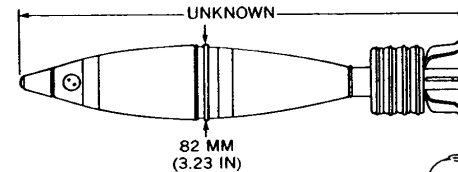

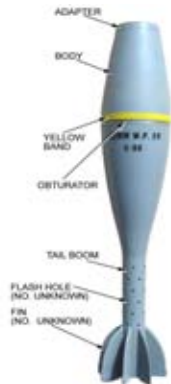

## YUGOSLAV PROJECTILE, 82-MM, SMOKE (WP), MORTAR, ER

Ordnance used with:  
PDB 332, PROJECTILE, PD

---

## U.S.S.R. CARTRIDGE, 73-MM, HE, OG-15P



Ordnance used with:  
GO-2, PROJECTILE , PD  
OG-9, 73-MM, HE-FRAG  
OG-9M, 73-MM, HE-FRAG  
SPG-9, 73MM, RECOILESS RIFLE

## SWEDISH CARTRIDGE, 84-MM, HE-FRAG, FFV 441B

Ordnance used with:  
FFV 447, PROJECTILE, MT  
FFV 441B, 84-MM, HE-FRAG  
M2 & M3, 84-MM SYSTEM, CARL-GUSTAF, RECOILLES...

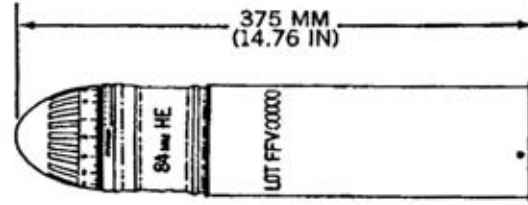

N.E.W. 738.05 G

## SWEDISH PROJECTILE, 84-MM, HE-FRAG, FFV 441B

Ordnance used with:  
FFV 441B, 84-MM, CARTRIDGE, HE-FRAG  
FFV 447, PROJECTILE, MT

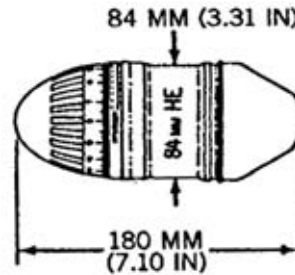

N.E.W. 359.00 G

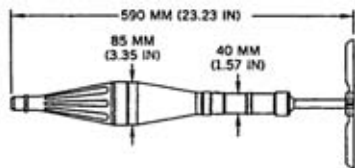

## CHINESE ROCKET, 85-MM, HEAT, TYPE 84

Ordnance used with:  
RPG-7, LNCHR.  
TYPE 69, LNCHR.

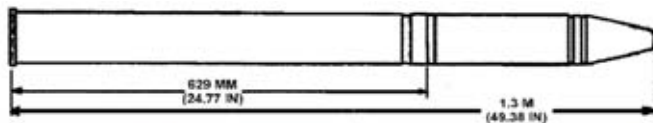

## U.S.S.R. CARTRIDGE, 85-MM, HEAT-FS, UBK-1M

Ordnance used with:  
BK-2M, 85-MM, HEAT-FS



## U.S.S.R. PROJECTILE, 85-MM, APHE-T, BR-365K

Ordnance used with:  
UBR-365K, 85-MM, CARTRIDGE, APHE-T  
MD-10, PROJECTILE, BD  
MD-7, FUZE, PROJECTILE, BD  
MD-8, PROJECTILE, BD

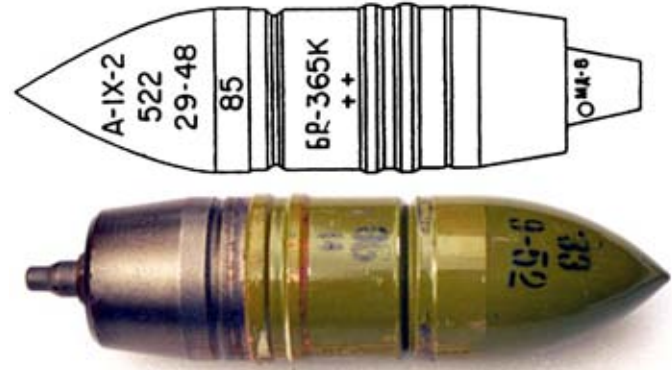

## U.S.S.R. PROJECTILE, 85-MM, FIXED, FRAG, O-365K

Ordnance used with:  
NSC-1, PROJECTILE, PDSD  
KTM-1, PROJECTILE, PD  
KTM-1U, PROJECTILE, PD  
KTM-1Y, PROJECTILE, PD  
KTM-2, PROJECTILE, PD  
KTM-3, PROJECTILE, PD  
KTM3-1, PROJECTILE, PD

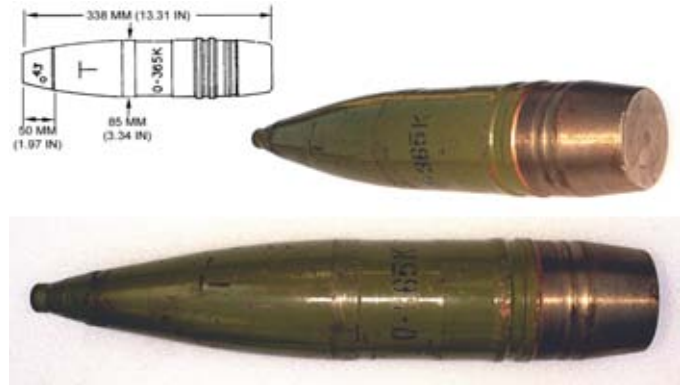

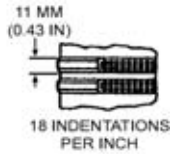
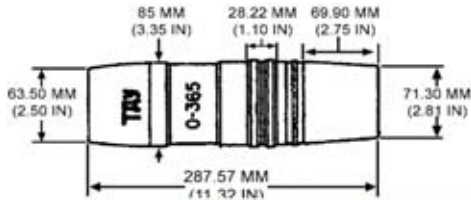

### U.S.S.R. PROJECTILE, 85-MM, HE, O-365 (ONE-PIECE)

Ordnance used with:  
 T-11, PROJECTILE, PTT  
 T-5, FUZE, PROJECTILE, PTT  
 VM-2, PROJECTILE, MT  
 UO-365, 85-MM, CARTRIDGE, HE  
 UO-365K, 85-MM, CARTRIDGE, FRAG



N.E.W. 650.00 G

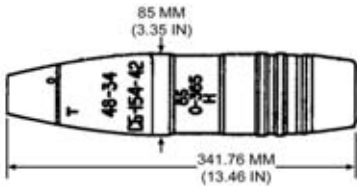

### U.S.S.R. PROJECTILE, 85-MM, HE, O-365 (TWO-PIECE)

Ordnance used with:  
 KTM-1, PROJECTILE, PD  
 KTM-1U, PROJECTILE, PD  
 KTM-1Y, PROJECTILE, PD  
 KTM-2, PROJECTILE, PD  
 KTM-3, PROJECTILE, PD  
 KTM3-1, PROJECTILE, PD  
 KTMZ-1, PROJECTILE, PD



N.E.W. 708.00 G

## U.S.S.R. PROJECTILE, 85-MM, HE, O-367A

Ordnance used with:  
KTM-1U, PROJECTILE, PD  
KTM-1Y, PROJECTILE, PD  
UO-367A, CARTRIDGE, 85MM, FRAG

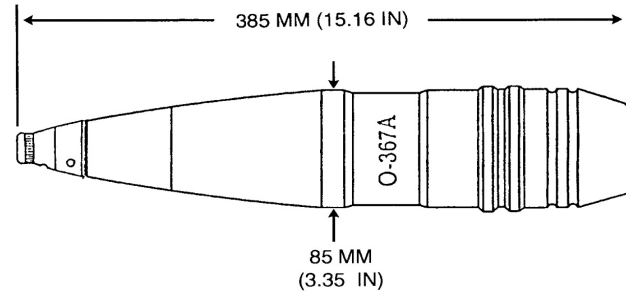

N.E.W. 670.00 G

## U.S.S.R. PROJECTILE, 85-MM, HVAP-T, BR-365P

Ordnance used with:  
UBR-365P, CARTRIDGE, 85MM, HVAP-T

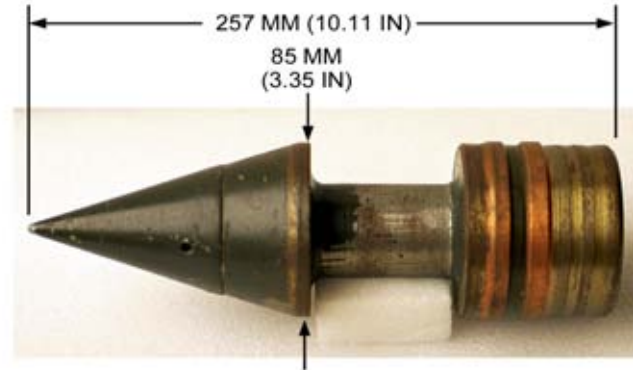

## U.S.S.R CARTRIDGE, 76-MM, UOF-354



Ordnance used with:  
KTM-1, PROJECTILE, PD  
KTM3-1, PROJECTILE, PD  
KTMZ-1, PROJECTILE, PD  
OF-350, 76-MM, HE-FRAG  
M1942 (ZIS-3), FIELD GUN, 76MM

---

## U.S.S.R. CARTRIDGE, 76-MM, FRAG-HE, UOF-354M



Ordnance used with:  
KTM-1, PROJECTILE, PD  
KTM-1U, PROJECTILE, PD  
KTM-1Y, PROJECTILE, PD  
KTM-3, PROJECTILE, PD  
KTM3-1, PROJECTILE, PD  
KTMZ-1, PROJECTILE, PD  
KTM3-1U, PROJECTILE, PD

## YUGOSLAV PROJECTILE, 90-MM, HEAT-T, M74

Ordnance used with:  
AU-16, PROJECTILE, PIBD  
M69, PROJECTILE, PIBD  
UT PE M69, PROJECTILE, PIBD  
UT-PE.M69, PROJECTILE, PIBD  
M74, 90-MM, HEAT-T, CARTRIDGE

N.E.W. 735.00 G



## U.S.S.R. PROJECTILE, 92-MM, INCENDIARY, (THERMOBARIC), RPO-A





## CHINESE CARTRIDGE, 57-MM, HE-T, TYPE 59

Ordnance used with:  
 ML-2  
 ML-2, PROJECTILE, PDS  
 ML2, PROJECTILE, PD  
 LIU 2, PROJECTILE, PDS  
 TYPE 59, 57MM, CARTRIDGE, HE  
 TYPE 59, 57MM, HE

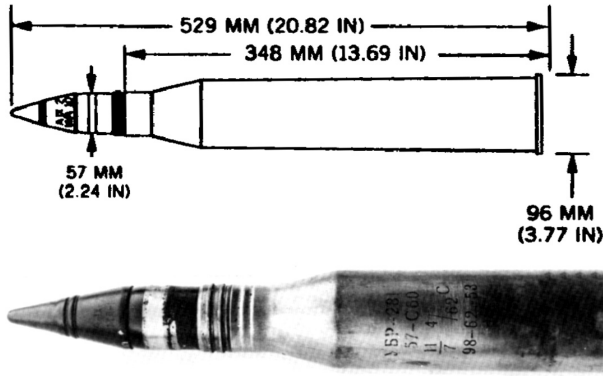

## U.S.S.R. CARTRIDGE, 57-MM, APHE-T, UBR-281

Ordnance used with:  
 MD-10, PROJECTILE, BD  
 BR-281, 57-MM, APHE-T  
 ZSU-57-2, AIR DEFENSE GUN, 57MM, TWIN  
 S-60, AIR DEFENSE GUN, 57MM, TOWED

N.E.W. 18.00 G

## U.S.S.R. CARTRIDGE, 57-MM, APHE-T, UBR-281U

Ordnance used with:  
MD-10, PROJECTILE, BD  
BR-281U, 57-MM, APHE-T  
ZSU-57-2, AIR DEFENSE GUN, 57MM, TWIN  
S-60, AIR DEFENSE GUN, 57MM, TOWED

N.E.W. 18.00 G

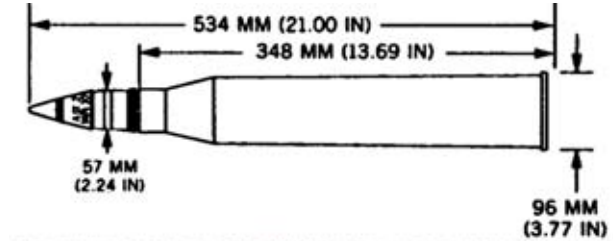

## U.S.S.R. CARTRIDGE, 57-MM, FRAG-T, OR-281U

Ordnance used with:  
MG-57, PROJECTILE, PDS  
MGZ-57, PROJECTILE, PDS  
OR-281U, 57-MM, FRAG-T  
ZSU-57-2, AIR DEFENSE GUN, 57MM, TWIN  
S-60, AIR DEFENSE GUN, 57MM, TOWED  
57-7N, PROJECTILE, PDS

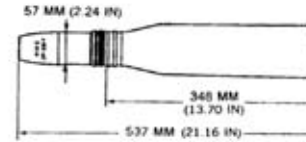

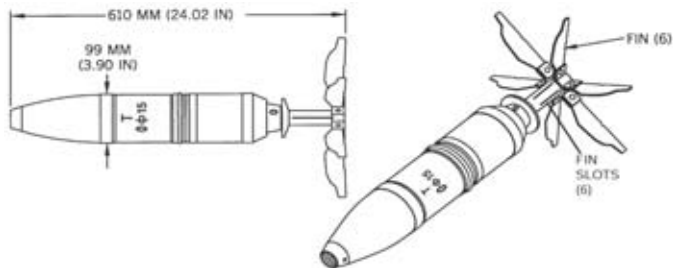

## U.S.S.R. PROJECTILE, 100-MM, FRAG-HE, OF15

Ordnance used with:  
 V-429E, PROJECTILE, PD  
 UOF-3, 100-MM, CARTRIDGE, FRAG-HE  
 UOF3, 100-MM, CARTRIDGE, HE



N.E.W. 2.23 KG

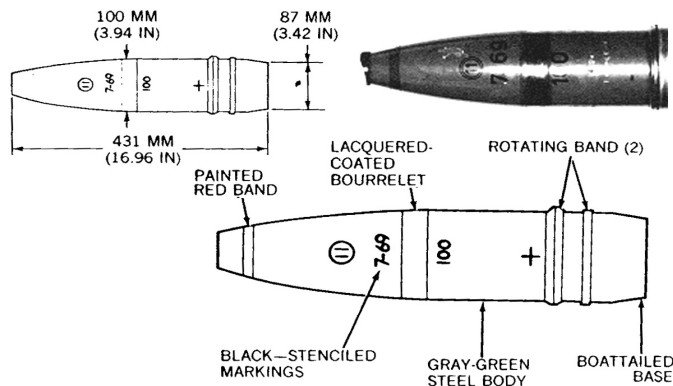

## BULGARIAN PROJECTILE, 100-MM, FRAG-HE, OF-412

Ordnance used with:  
 VUBS-1, PROJECTILE, PDS  
 NSC-1, PROJECTILE, PDS  
 RGM, PROJECTILE, PD  
 RGM-2, PROJECTILE, PD  
 RGM-3, PROJECTILE, PD  
 RGM-6, PROJECTILE, PD  
 UTIU M63P2, PROJECTILE, PD



## BULGARIAN PROJECTILE, 100-MM, HEAT, BK5

Ordnance used with:  
GPV-2, PROJECTILE, PIBD, SPITBACK  
UAPHC4, CARTRIDGE, 100MM, HEAT-T-FS  
UBK-4, CARTRIDGE, 100MM, HEAT

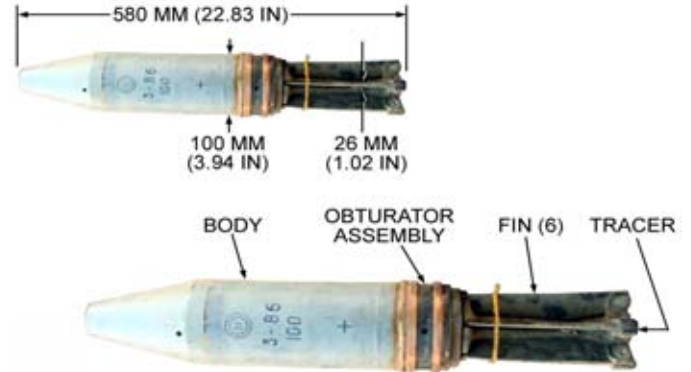

## CZECHOSLOVAKIAN PROJECTILE, 100-MM, APHE-T, PSV

Ordnance used with:  
JPSV CARTRIDGE, 100-MM, APHE-T  
DBR-2, PROJECTILE, BD  
DZ 30, PROJECTILE, BD  
PD 30, PROJECTILE, BD

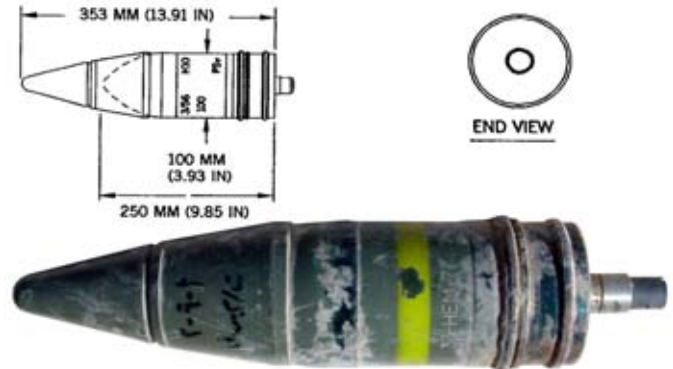

N.E.W. 96.00 G

**PAKISTANI CARTRIDGE, 100-MM, APFSDS-T, 100-MM APFSDS-T**

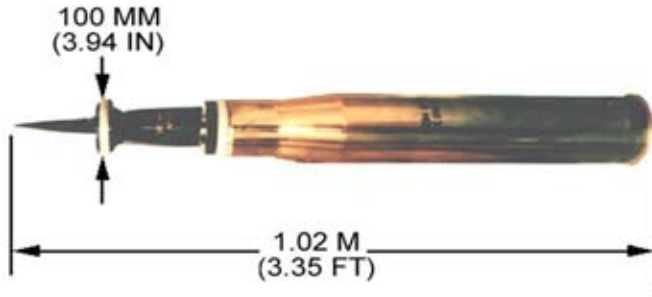

**RUSSIAN PROJECTILE, 100-MM, HEAT-T, 3BK17M**

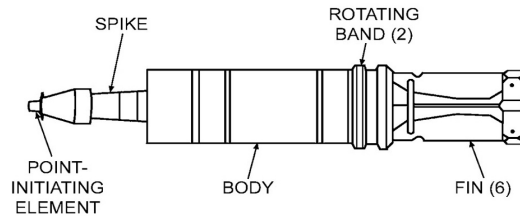
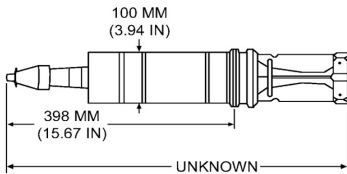

Ordnance used with:  
3UBK9, CARTRIDGE, 100-MM, HEAT-FS  
V-15, FUZE, PROJECTILE, PIBD  
UBK-9M, CARTRIDGE, 100MM, HEAT

## U.S.S.R. CARTRIDGE, 100-MM, 3UBM10 WITH PROJECTILE, APFSDS, 3BM24

Ordnance used with:  
3BM24, 100-MM, APFSDS  
BM-24, 100-MM, APFSDS  
3UBM10, CARTRIDGE, 100-MM, APFSDS  
UBM-10, CARTRIDGE, 100-MM, APFSDS

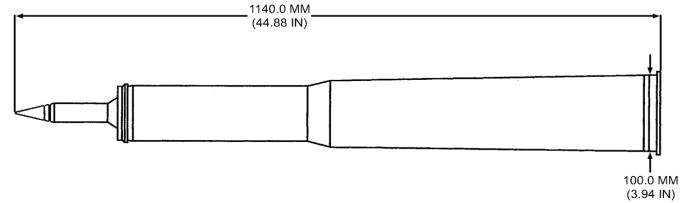

## U.S.S.R. CARTRIDGE, 100-MM, FRAG-HE, 3UOF10 (UOF-10)

Ordnance used with:  
UTIU M63P2, PROJECTILE, PD  
V-429, PROJECTILE, PD  
V-429E, PROJECTILE, PD  
3OF32, 100-MM, HE  
OF-32, 100-MM, FRAG-HE

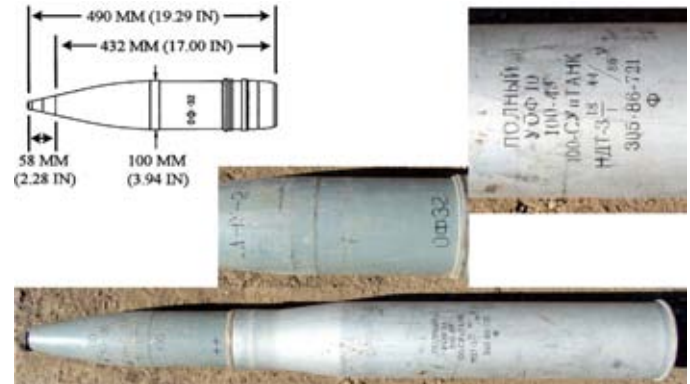

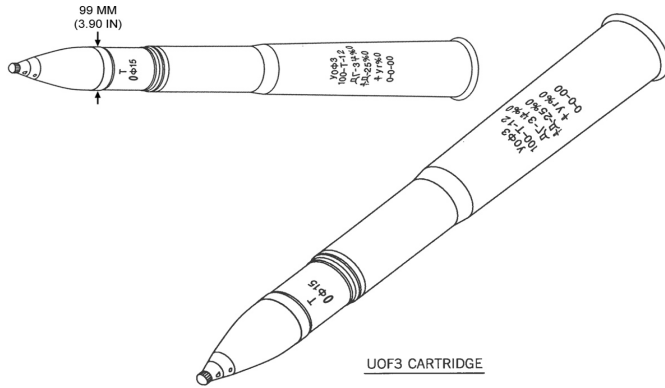

**U.S.S.R. CARTRIDGE, 100-MM, FRAG-HE, UOF-3**

Ordnance used with:  
 V-429E, PROJECTILE, PD  
 OF15, 100-MM, FRAG-HE  
 OF15, 100-MM, HE

UOF3 CARTRIDGE

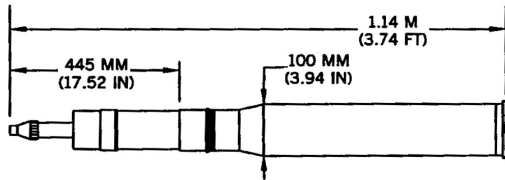

**U.S.S.R. CARTRIDGE, 100-MM, HEAT-FS, 3UBK9**

Ordnance used with:  
 3BK17M, 100-MM, HEAT-T  
 BK-17M

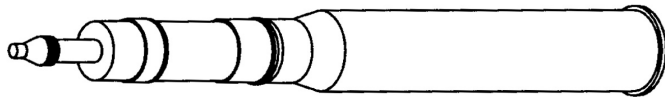

## U.S.S.R. CARTRIDGE, 100-MM, HVAPDS-T, UBM-6

Ordnance used with:  
BM-8, 100-MM, HVAPDS-T  
BM8, 100-MM, HVAPDS-T

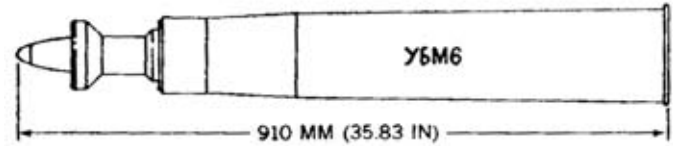

---

## U.S.S.R. PROJECTILE, 100-MM, APHE OR APHE-T, BR-412B

Ordnance used with:  
DBR, PROJECTILE, BD  
DBR-2, PROJECTILE, BD  
UBR-412B, CARTRIDGE, 100MM, APHE-T  
UBZR, CARTRIDGE, 100-MM, APHE-T  
MD-8, PROJECTILE, BD  
UBR-412, CARTRIDGE, 100-MM, APHE OR APHE-T

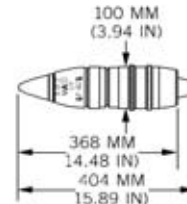

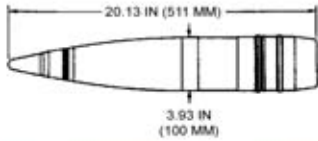

## U.S.S.R. PROJECTILE, 100-MM, FRAG, O-415

Ordnance used with:  
 KTM-1, PROJECTILE, PD  
 VM-30, PROJECTILE, MT  
 VM-30L, PROJECTILE, MT  
 UO-415, 100MM, CARTRIDGE, FRAG

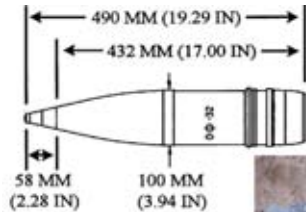

## U.S.S.R. PROJECTILE, 100-MM, FRAG-HE, OF-32

Ordnance used with:  
 UTIU M63P2, PROJECTILE, PD  
 V-429, PROJECTILE, PD  
 V-429E, PROJECTILE, PD  
 3UOF10, 100-MM, CARTRIDGE, FRAG-HE  
 UOF-10, 100-MM, CARTRIDGE, HE

N.E.W. 1.70 KG

## U.S.S.R. PROJECTILE, 100-MM, FRAG-HE, OF-412

Ordnance used with:  
NSC-1, PROJECTILE, PDS  
RGM, PROJECTILE, PD  
RGM-2, PROJECTILE, PD  
RGM-3, PROJECTILE, PD  
RGM-6, PROJECTILE, PD  
UTIU M63P2, PROJECTILE, PD  
V-429, PROJECTILE, PD

N.E.W. 1.46 KG

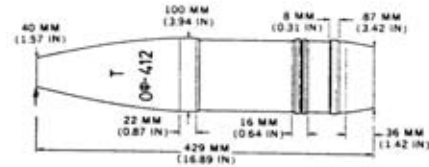

## U.S.S.R. PROJECTILE, 100-MM, HEAT, 3BK16M

Ordnance used with:  
3UBK8, 100-MM, CARTRIDGE, HEAT-FS  
V-15, FUZE, PROJECTILE, PIBD  
UBK-8M, CARTRIDGE, 100MM, HEAT

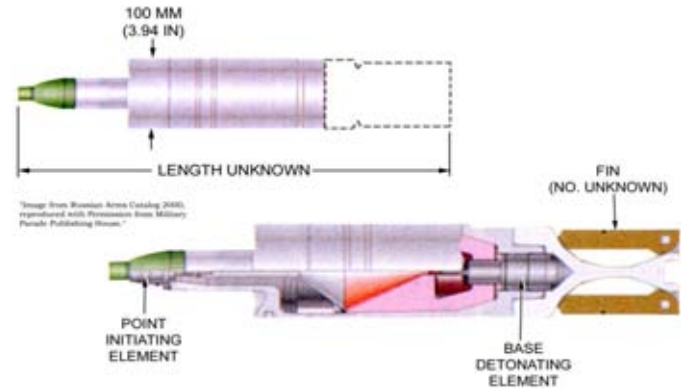

## U.S.S.R. PROJECTILE, 100-MM, HEAT-FS, 3BK-5M

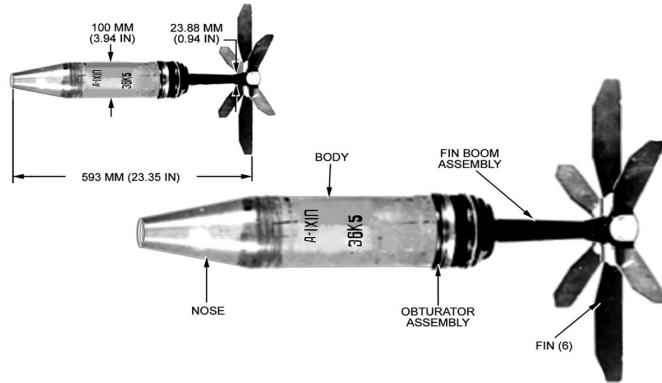

Ordnance used with:  
GPV-2, PROJECTILE, PIBD, SPITBACK  
UBK-4M, CARTRIDGE, 100-MM, HEAT-FS

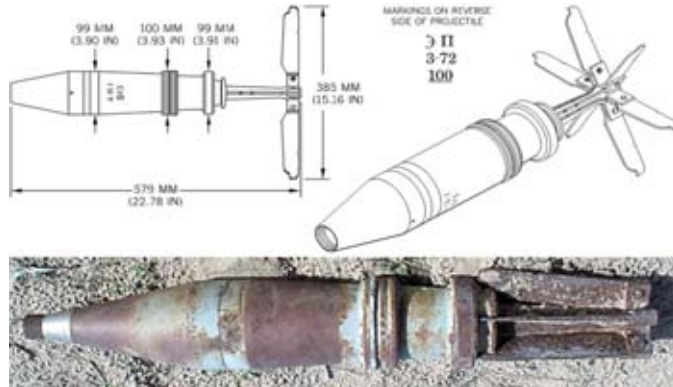

## U.S.S.R. PROJECTILE, 100-MM, HEAT-FS-T, BK-3

Ordnance used with:  
GPV-2, PROJECTILE, PIBD, SPITBACK  
GPV-3, PROJECTILE, PIBD  
UBK-2, 100MM, CARTRIDGE, HEAT



## U.S.S.R. PROJECTILE, 100-MM, HVAPDS-T, BM8

Ordnance used with:  
UBM-6, 100-MM, CARTRIDGE, HVAPDS-T

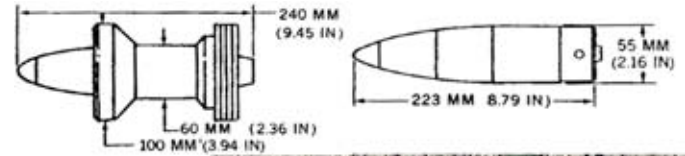

## YUGOSLAV PROJECTILE, 100-MM, HEAT-T, M69

Ordnance used with:  
AU-16, PROJECTILE, PIBD  
M69, PROJECTILE, PIBD  
UT PE M69, PROJECTILE, PIBD  
UT-PE.M69, PROJECTILE, PIBD  
M69, 100-MM, HEAT-T, CARTRIDGE



## U.S.S.R. CARTRIDGE, 85-MM, APHE-T, UBR-365K



Ordnance used with:  
BR-365K, 85 MM, APHE-T  
MD-10, PROJECTILE, BD  
MD-5, PROJECTILE, BD  
MD-7, FUZE, PROJECTILE, BD  
MD-8, PROJECTILE, BD  
KS-12, AIR DEFENSE GUN, 85MM, TOWED

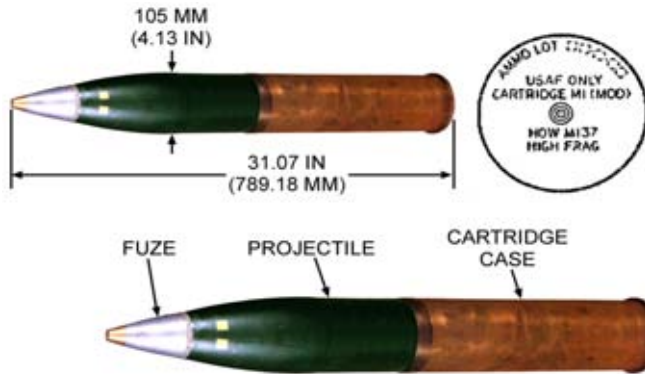

## U.S. CARTRIDGE, 105-MM, HE, HIGH FRAG M1 (MOD)

Ordnance used with:  
M557, FUZE, PROJECTILE, PD  
M732 PROJECTILE, PROX.  
MK 399 MOD 1, FUZE, PROJECTILE, PD  
FMU-153/B PROJECTILE, PD  
M732A2, PROJECTILE, PROX.  
M732E2, PROJECTILE, PROX.  
FMU-160/B PROJECTILE, PROX.  
N.E.W. 3.62 KG

## U.S. CARTRIDGE, 105-MM, HE, M1 (MOD)

Ordnance used with:

M557, FUZE, PROJECTILE, PD

M732 PROJECTILE, PROX.

MK 399 MOD 1, FUZE, PROJECTILE, PD

MK 407 MOD 1, FUZE, PROJECTILE, PD

M1 (MOD), PROJECTILE, 105MM, HE

FMU-153/B PROJECTILE, PD

M732A2, PROJECTILE, PROX.

N.E.W. 3.39 KG

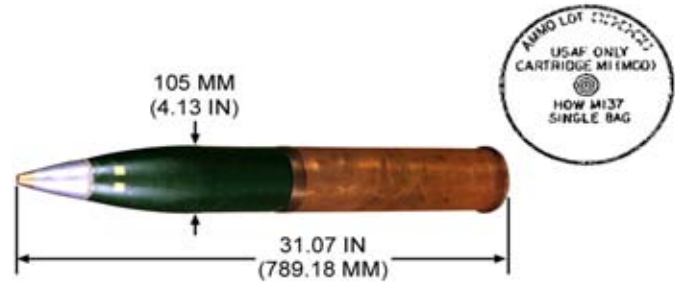

## U.S. CARTRIDGE, 105-MM, HE, M760

Ordnance used with:

M582, FUZE, PROJECTILE, MTSQ

M582A1, FUZE, PROJECTILE, MTSQ

M732 PROJECTILE, PROX.

M739, FUZE, PROJECTILE, PD

M739A1, FUZE, PROJECTILE, PD

M760, 105-MM, HE

MK 399 MOD 1, FUZE, PROJECTILE, PD

N.E.W. 2.18 KG

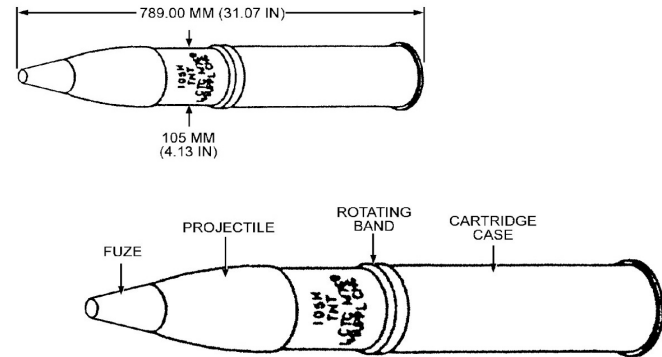

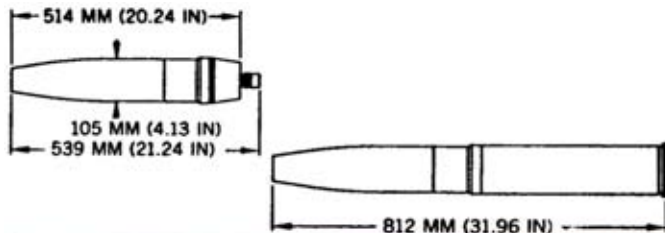

## U.S. CARTRIDGE, 105-MM, HERA, M913

Ordnance used with:  
 M582, FUZE, PROJECTILE, MTSQ  
 M582A1, FUZE, PROJECTILE, MTSQ  
 M728, FUZE, PROJECTILE, PROX.  
 M732 PROJECTILE, PROX.  
 M739, FUZE, PROJECTILE, PD  
 MK 399 MOD 1, FUZE, PROJECTILE, PD  
 M767, FUZE, PROJECTILE, ET

N.E.W. 5.76 KG

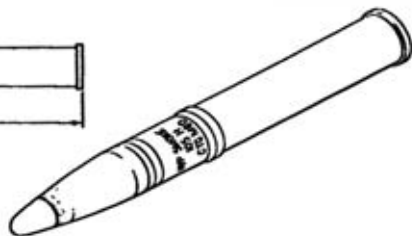
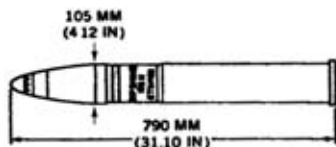

## U.S. CARTRIDGE, 105-MM, SMOKE, WP, M60A1

Ordnance used with:  
 M508, PROJECTILE, PD  
 M508A1, PROJECTILE, PD  
 M51A5, FUZE, PROJECTILE, PD  
 M55, PROJECTILE, TSQ  
 M557, FUZE, PROJECTILE, PD  
 M55A2, FUZE, PROJECTILE, TSQ  
 M55A3, FUZE, PROJECTILE, TSQ

N.E.W. 3.00 LB

## U.S. PROJECTILE, 105-MM, HE, HF M1 (MOD)

Ordnance used with:

M501, FUZE, PROJECTILE, MTSQ  
M501A1, FUZE, PROJECTILE, MTSQ

M557, FUZE, PROJECTILE, PD  
M564, FUZE, PROJECTILE, MTSQ

M732 PROJECTILE, PROX.

MK 399 MOD 1, FUZE, PROJECTILE, PD  
FMU-153/B PROJECTILE, PD

N.E.W. 2.30 KG

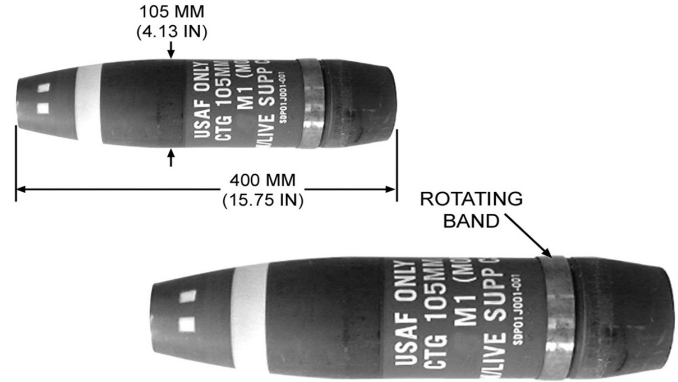

## U.S. PROJECTILE, 105-MM, HE, M1 (MOD)

Ordnance used with:

M501, FUZE, PROJECTILE, MTSQ  
M501A1, FUZE, PROJECTILE, MTSQ

M557, FUZE, PROJECTILE, PD  
M564, FUZE, PROJECTILE, MTSQ

M732 PROJECTILE, PROX.

MK 399 MOD 1, FUZE, PROJECTILE, PD  
MK 407 MOD 1, FUZE, PROJECTILE, PD

N.E.W. 2.22 KG

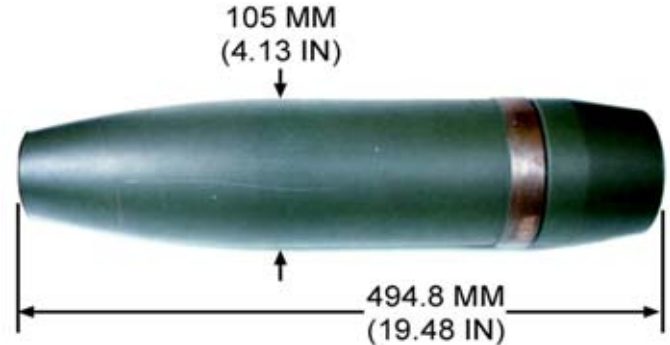

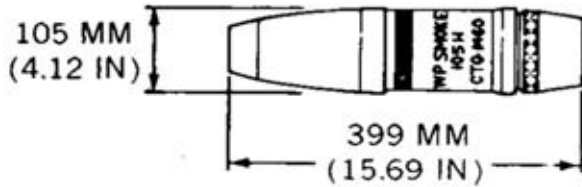

## U.S. PROJECTILE, 105-MM, SMOKE, WP, M60-SERIES

Ordnance used with:

- M501, FUZE, PROJECTILE, MTSQ
- M501A1, FUZE, PROJECTILE, MTSQ
- M508, PROJECTILE, PD
- M508A1, PROJECTILE, PD
- M51A5, FUZE, PROJECTILE, PD
- M55, PROJECTILE, TSQ
- M557, FUZE, PROJECTILE, PD

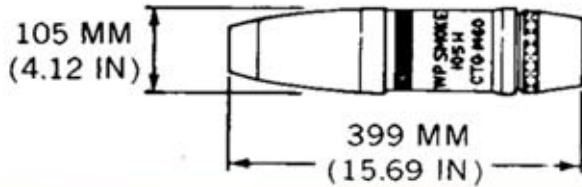

## U.S. PROJECTILE, 105-MM, SMOKE, WP, M60A2

Ordnance used with:

- M501, FUZE, PROJECTILE, MTSQ
- M501A1, FUZE, PROJECTILE, MTSQ
- M508, PROJECTILE, PD
- M508A1, PROJECTILE, PD
- M51A5, FUZE, PROJECTILE, PD
- M55, PROJECTILE, TSQ
- M557, FUZE, PROJECTILE, PD



## U.S.S.R. PROJECTILES, 107-MM, HE, FRAG, OF-841 & OF-841A

Ordnance used with:  
D-1, PROJECTILE, TSQ  
GVM, FUZE, PROJECTILE, PD  
GVMZ, FUZE, PROJECTILE, PD  
GVMZ-1, FUZE, PROJECTILE, PD  
GVMZ-7, PROJECTILE, PD

N.E.W. 2.10 KG

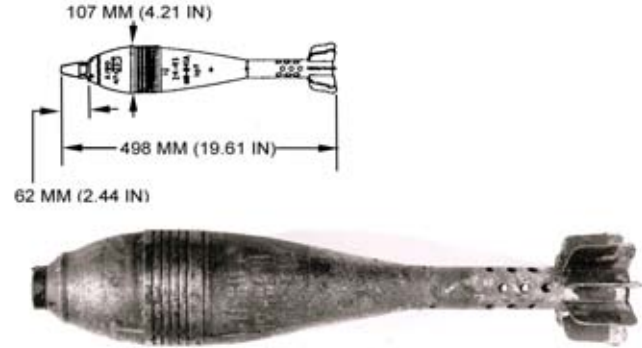

## CHINESE CARTRIDGE, 75-MM, RR, HEAT, TYPE 52

Ordnance used with:  
TYPE 52, 75 MM, RR, HEAT

N.E.W. 1.05 KG

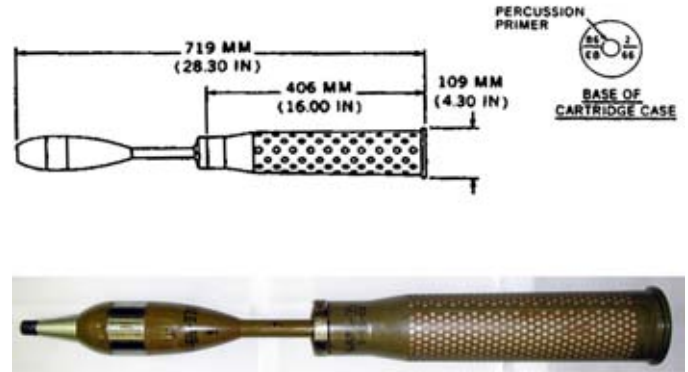

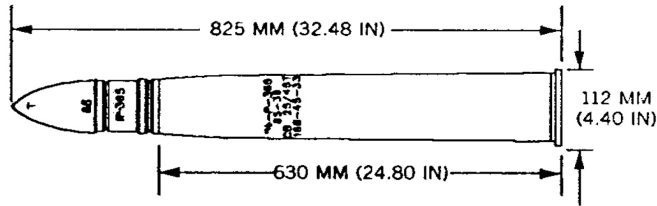

### U.S.S.R. CARTRIDGE, 85-MM, APHE-T, UBR-365

Ordnance used with:  
 BR-365, 85-MM, APHE-T  
 MD-10, PROJECTILE, BD  
 MD-8, PROJECTILE, BD  
 KS-12, AIR DEFENSE GUN, 85MM, TOWED

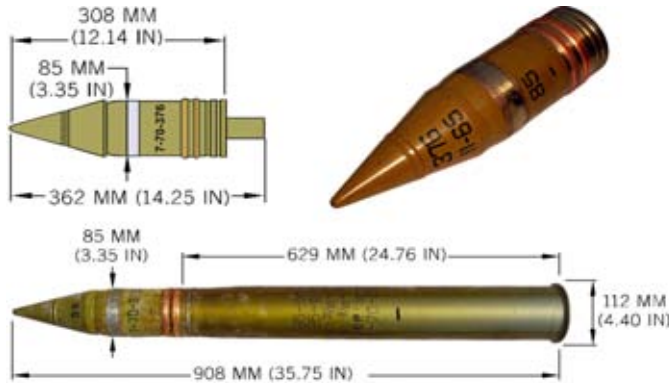

### U.S.S.R. CARTRIDGE, 85-MM, APHE-T, UBR-367 WITH PROJECTILE BR-367

Ordnance used with:  
 TYPE 367, 85-MM, CARTRIDGE, APHE-T  
 UBR-367, 85-MM, CARTRIDGE, APHE-T  
 BR-367, 85-MM, APHE-T  
 TYPE 376, 85-MM, APHE-T  
 DBR, PROJECTILE, BD  
 DBR-2, PROJECTILE, BD  
 N.E.W. 127.00 G



## U.S.S.R. CARTRIDGE, 85-MM, FRAG, UO-365K

Ordnance used with:  
O-365, 85-MM, PROJECTILE, HE, (2 PIECE)  
O-365K, 85-MM, FRAG  
KTM-1, PROJECTILE, PD  
KTM-1U, PROJECTILE, PD  
KTM-1Y, PROJECTILE, PD  
KTM3-1, PROJECTILE, PD  
KTMZ-1, PROJECTILE, PD

N.E.W. 3.39 KG



## U.S.S.R. CARTRIDGE, 85-MM, HE, UO-365

Ordnance used with:  
O-365, 85-MM, PROJECTILE, HE, (2 PIECE)  
KTM3-1, PROJECTILE, PD  
KTMZ-1, PROJECTILE, PD  
T-11, PROJECTILE, PTT  
T-5, FUZE, PROJECTILE, PTT  
VM-2, PROJECTILE, MT  
O-365 (ONE-PIECE), 85-MM, HE-FRAG



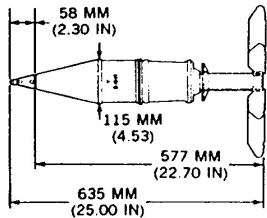

**U.S.S.R. CARTRIDGE, 115-MM, FRAG, HE, UOF-1**

Ordnance used with:  
 OF-11, 115-MM, FRAG-HE  
 V-429E, PROJECTILE, PD

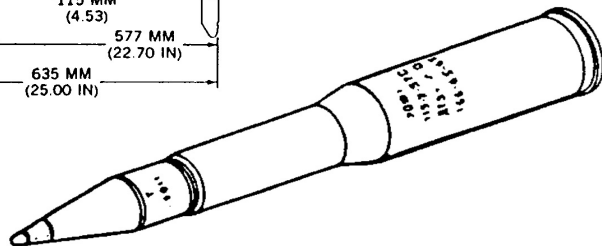

FRONT



REVERSE



CARTRIDGE CASE

**MARKINGS**

**U.S.S.R. CARTRIDGE, 115-MM, FRAG-HE, 3UOF37 (UOF-37)**

Ordnance used with:  
 3OF27, 115-MM, FRAG-HE  
 OF-27, 115-MM, FRAG-HE  
 V-429E, PROJECTILE, PD



**U.S.S.R. CARTRIDGE, 115-MM, HEAT-FS, 3UBK7 W/  
PROJECTILE, MODEL UNKNOWN**

Ordnance used with:  
V-15, FUZE, PROJECTILE, PIBD  
3BK15M, 115-MM, HEAT  
BK-15M, 115-MM, HEAT

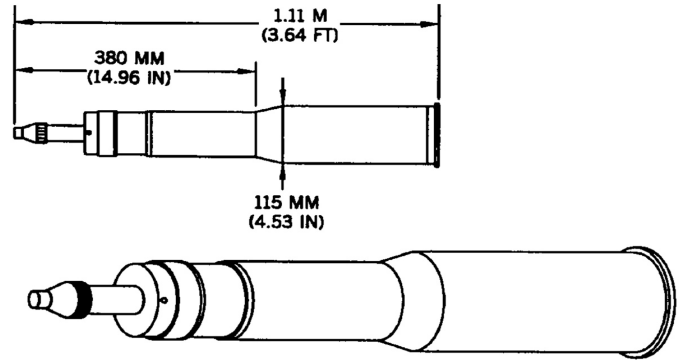

**U.S.S.R. PROJECTILE, 115-MM, FRAG, HE, OF-11**

Ordnance used with:  
UTIU M63P2, PROJECTILE, PD  
V-429, PROJECTILE, PD  
V-429E, PROJECTILE, PD  
UOF-1, CARTRIDGE, 115-MM, FRAG, HE

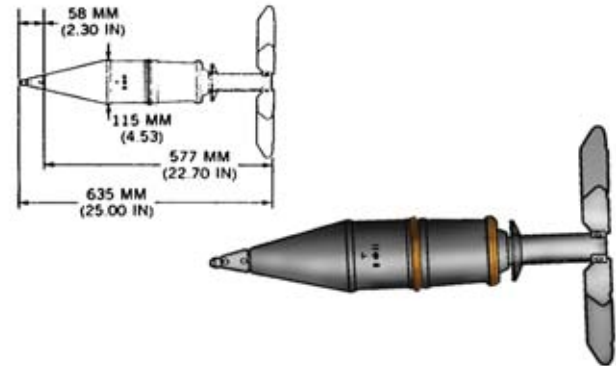

## U.S.S.R. PROJECTILE, 115-MM, FRAG-HE, OF-27



Ordnance used with:  
V-429E, PROJECTILE, PD  
3UOF37, 115-MM, CARTRIDGE, FRAG-HE  
UOF-37, 115-MM, CARTRIDGE, FRAG-HE

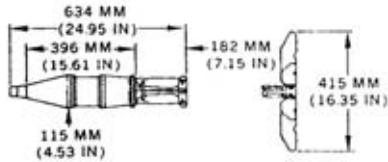

## U.S.S.R. PROJECTILE, 115-MM, FS, HEAT, BK-4M

Ordnance used with:  
GPV-2, PROJECTILE, PIBD, SPITBACK  
UBK-3, 115MM, CARTRIDGE, HEAT-T  
UBK-3M, 115MM, CARTRIDGE, FS, HEAT

N.E.W. 1.46 KG

## U.S.S.R. PROJECTILE, 115-MM, HE, FRAG, OF-18

Ordnance used with:  
UTIU M63P2, PROJECTILE, PD  
V-429, PROJECTILE, PD  
V-429E, PROJECTILE, PD  
D-1-U, PROJECTILE, TSQ  
D-1U, PROJECTILE, TSQ  
UOF-6, 115-MM, CARTRIDGE, HE, FRAG

N.E.W. 2.70 KG

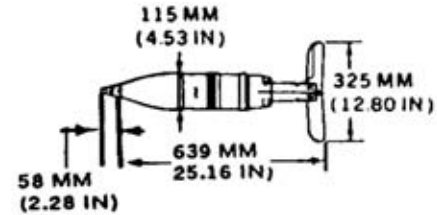

## U.S.S.R. PROJECTILE, 115-MM, HEAT, 3BK15M

Ordnance used with:  
3UBK7, CARTRIDGE, 115-MM, HEAT-FS  
UBK-7, CARTRIDGE, 115-MM, HEAT-FS  
V-15, FUZE, PROJECTILE, PIBD

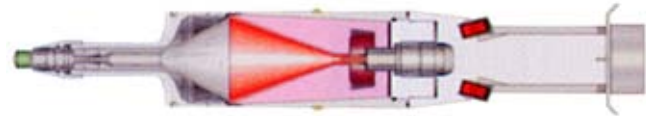

\*Image from Russian Arms Catalog, Vol. VII, reproduced with Permission from Military Parade Publishing House.\*

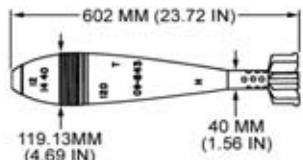

### U.S.S.R. PROJECTILE, 120-MM, HE, MORTAR, OF-843

Ordnance used with:  
 GVM, FUZE, PROJECTILE, PD  
 GVMZ, FUZE, PROJECTILE, PD  
 GVMZ-1, FUZE, PROJECTILE, PD  
 GVMZ-7, PROJECTILE, PD  
 M-1, PROJECTILE, PDSQ  
 TYPE 1, PROJECTILE, PD  
 M-12, FUZE, PROJECTILE, PD  
 N.E.W. 2.68 KG

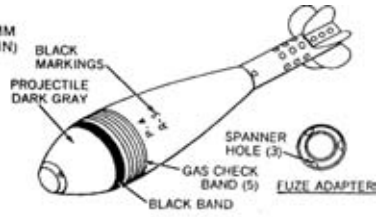
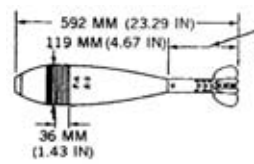

### U.S.S.R. PROJECTILE, 120-MM, MORTAR, SMOKE (WP) D-5

Ordnance used with:  
 M-12, FUZE, PROJECTILE, PD  
 MP-4, FUZE, PROJECTILE, PD  
 M-4, PROJECTILE, PD



**CHINESE PROJECTILE, 120-MM, MORTAR,  
ILLUMINATING, MODEL UNKNOWN**

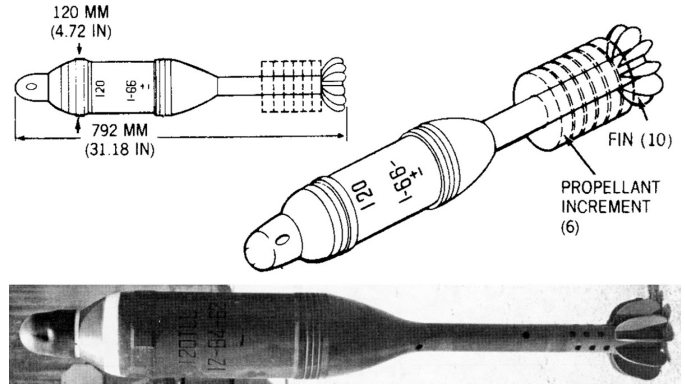

N.E.W. 2.10 KG

**IRANIAN CARTRIDGE, 120-MM, HE, MORTAR, MODEL  
UNKNOWN**

Ordnance used with:  
AZ111 A2, PROJECTILE, PD  
AZ111-A2  
AZ111, PROJECTILE, PD  
DM111, PROJECTILE, PD  
UNKNOWN, 120MM, MORTAR, HE

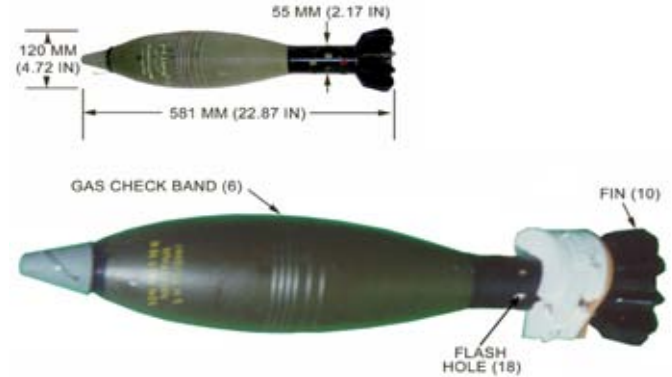

N.E.W. 2.30 KG

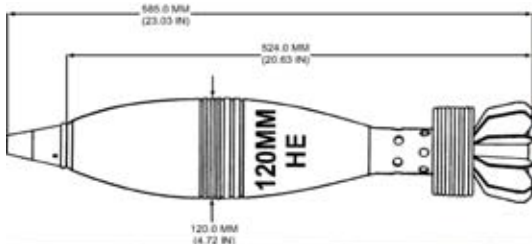

**IRANIAN PROJECTILE, 120-MM, HE, MORTAR, MODEL UNKNOWN**

Ordnance used with:  
 AZ111 A2, PROJECTILE, PD  
 AZ111-A2  
 AZ111, PROJECTILE, PD  
 DM111, PROJECTILE, PD  
 MDL. UNKNOWN, CARTRIDGE, 120MM, HE, MORTAR



N.E.W. 2.30 KG

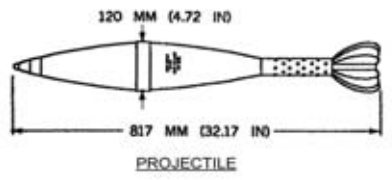

**SPANISH CARTRIDGE, 120-MM, MORTAR, HE, AE-100**

Ordnance used with:  
 M734 PROJECTILE, MULTIOPTION





## U.S.S.R. CARTRIDGE, 120-MM, MORTAR, ILLUM, S-843

Ordnance used with:  
S-843, 120-MM, MORTAR, ILLUMINATION  
T-1, PROJECTILE, TSQ

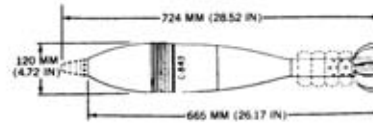

N.E.W. 367.00 G

## U.S.S.R. PROJECTILE, 115-MM, HVAP-FS-DS-T BM-6

Ordnance used with:  
UBM-5, 115MM, CARTRIDGE, APFSDS-T

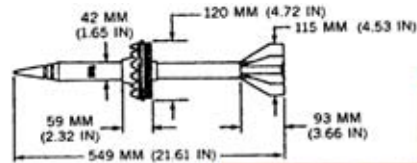

## U.S.S.R. PROJECTILE, 120-MM, HE, MORTAR, OF-843B

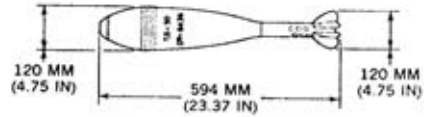

Ordnance used with:  
GVMZ-7, PROJECTILE, PD  
M-12, FUZE, PROJECTILE, PD  
MP-4, FUZE, PROJECTILE, PD  
V-22, FUZE, PROJECTILE, PD  
MP-4, PROJECTILE, PD  
M-12 (MODIFIED), FUZE, PROJECTILE, PD

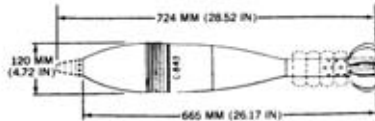

## U.S.S.R. PROJECTILE, 120-MM, MORTAR, ILLUM, S-843

Ordnance used with:  
T-1, PROJECTILE, TSQ  
S-843, 120-MM, MORTAR, CARTRIDGE, ILLUMINATION

## YUGOSLAV CARTRIDGE, 120-MM, HE, MORTAR, M62P3

Ordnance used with:  
AU-29, PROJECTILE, PD  
UTU M78, PROJECTILE, PD  
UT M68 P1, PROJECTILE, PD  
UT M68P1, PROJECTILE, PD  
UT.M68 P1, PROJECTILE, PD  
MU K92, PROJECTILE, PD  
UT M93, PROJECTILE, PD

N.E.W. 2.30 KG

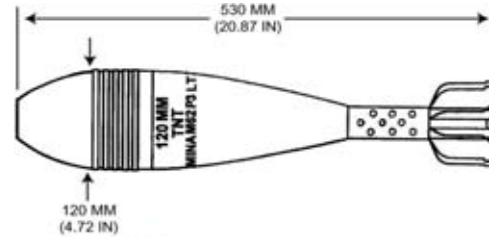

## U.S.S.R. PROJECTILE, 122-MM, SMOKE, WP, D-4

Ordnance used with:  
RGM-2, PROJECTILE, PD  
RGM-3, PROJECTILE, PD  
ZH10, 122MM, PROPELLING CHARGE, REDUCED  
ZH-9, 122 MM, PROPELLING CHARGE  
ZH-9, 122MM, PROPELLING CHARGE, FULL

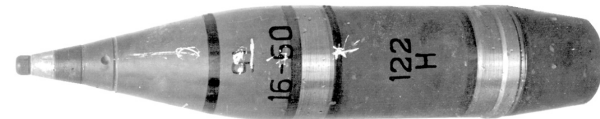
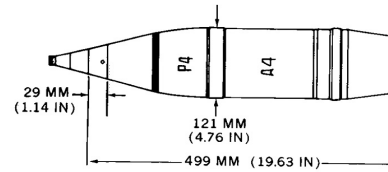

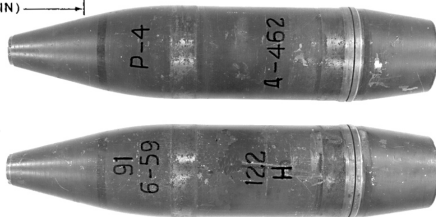
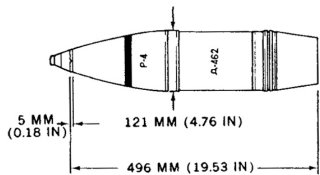

## U.S.S.R. PROJECTILE, 122-MM, SMOKE, WP, D-462

Ordnance used with:  
 KT-1, FUZE, PROJECTILE, PD  
 KT-2, FUZE, PROJECTILE, PD  
 KT-3, FUZE, PROJECTILE, PD  
 KTM-1, PROJECTILE, PD  
 KTM-1U, PROJECTILE, PD  
 KTM-1Y, PROJECTILE, PD  
 KTM-2, PROJECTILE, PD

N.E.W. 158.00 G

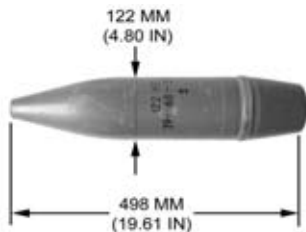

## CHINESE PROJECTILE, 122-MM, HE, TYPE 54

Ordnance used with:  
 DRL08, PROJECTILE, PDSQ  
 MD-82  
 MD82, PROJECTILE, PROX.  
 ML-4  
 ML4, PROJECTILE, PD  
 ML-5  
 ML5, PROJECTILE, PD

N.E.W. 4.30 KG

**CHINSESE PROJECTILE, 122-MM, HE, BB, MODEL UNKNOWN**

Ordnance used with:  
ML-4A  
ML4A, PROJECTILE, PD  
TYPE 83 CARTRIDGE, 122-MM, HE-FRAG, BB



N.E.W. 3.40 KG

---

**EGYPTIAN PROJECTILE, 122-MM, HE, H/38**

Ordnance used with:  
AU-18, PROJECTILE, PD  
UTIU M71, PROJECTILE, PD  
H/38, CARTRIDGE, 122MM, HE  
M362, PROJECTILE, PD



N.E.W. 3.50 KG

---

## POLISH PROJECTILE, 122-MM, HE-FRAG, OF-462

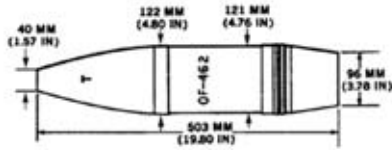

Ordnance used with:  
RG-6, PROJECTILE, PD  
RGM, PROJECTILE, PD  
RGM-2, PROJECTILE, PD  
RGM-2M, PROJECTILE, PD  
RGM-3, PROJECTILE, PD  
RGM-6, PROJECTILE, PD  
D30, 122MM, HOWITZER, TOWED

---

## U.S.S.R. PROJECTILE, 122-MM, FLECHETTE, SH1 (SH-1)



## U.S.S.R. PROJECTILE, 122-MM, FRAG, HE, OF-46ZH

Ordnance used with:  
RGM, PROJECTILE, PD  
RGM-2, PROJECTILE, PD  
RGM-3, PROJECTILE, PD

N.E.W. 3.46 KG

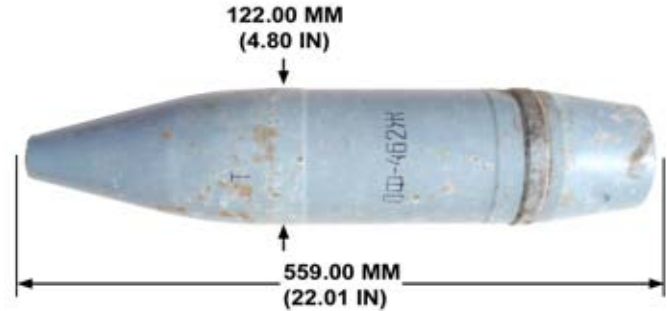

## U.S.S.R. PROJECTILE, 122-MM, FRAG-HE, OF-56

Ordnance used with:  
PF 122, PROJECTILE, PROXIMITY/PD  
PF-122, PROJECTILE, PROXIMITY/PD  
PF122, PROJECTILE, PROXIMITY/PD  
D-1, PROJECTILE, TSQ  
RGM-2, PROJECTILE, PD  
RGM-2M, PROJECTILE, PD  
RGM-3, PROJECTILE, PD

N.E.W. 4.40 KG

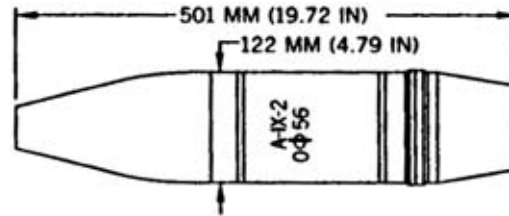

## U.S.S.R. PROJECTILE, 122-MM, HE, FRAG, OF-462

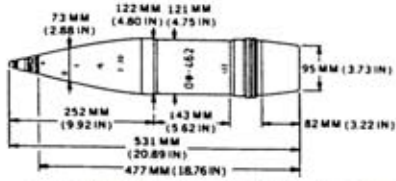

Ordnance used with:  
D-1, PROJECTILE, TSQ  
GVM, FUZE, PROJECTILE, PD  
GVMZ, FUZE, PROJECTILE, PD  
GVMZ-1, FUZE, PROJECTILE, PD  
RG-6, PROJECTILE, PD  
RGM, PROJECTILE, PD  
RGM-2, PROJECTILE, PD

## U.S.S.R. PROJECTILE, 122-MM, HE, FRAG, OF-472

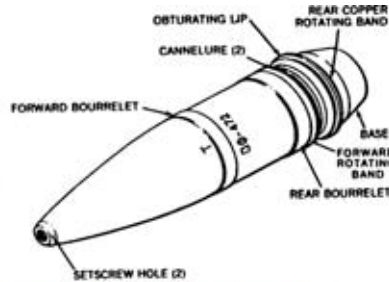
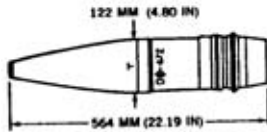

Ordnance used with:  
D-1, PROJECTILE, TSQ  
RGM-2, PROJECTILE, PD  
RGM-6, PROJECTILE, PD  
AR 7 (SIGNAL), PROJECTILE, PROXIMITY/PD  
UTIU M63P2, PROJECTILE, PD  
V-429, PROJECTILE, PD  
V-429E, PROJECTILE, PD  
N.E.W. 3.00 KG



## U.S.S.R. PROJECTILE, 122-MM, HE-FRAG, OF-462A

Ordnance used with:  
RG-6, PROJECTILE, PD  
RGM, PROJECTILE, PD  
RGM-2, PROJECTILE, PD  
RGM-6, PROJECTILE, PD  
D-1-U, PROJECTILE, TSQ  
D-1U, PROJECTILE, TSQ  
ZH-463, 122MM, PROPELLING CHARGE

N.E.W. 3.22 KG

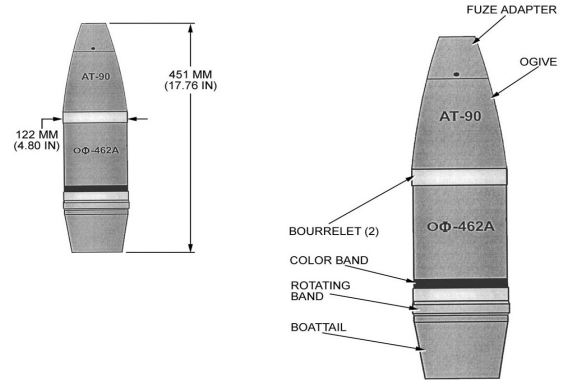

## U.S.S.R. PROJECTILE, 122-MM, HEAT-FS, BK 13

Ordnance used with:  
V-15, FUZE, PROJECTILE, PIBD  
ZH-9, 122 MM, PROPELLING CHARGE  
ZH-9, 122MM, PROPELLING CHARGE, FULL  
3UBK-9, 122-MM, CARTRIDGE, HEAT-FS-T  
VBK9, 122MM, CARTRIDGE, HEAT-T

N.E.W. 1.81 KG

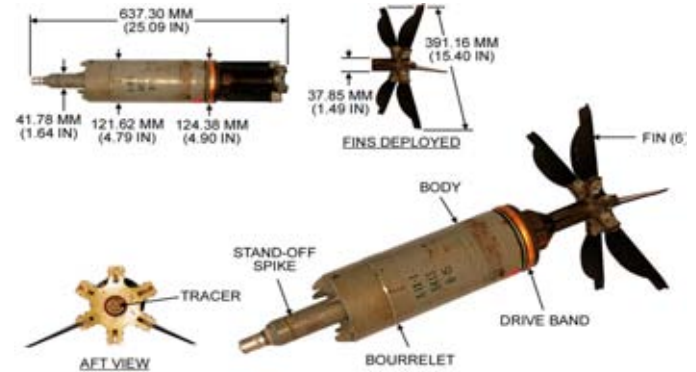

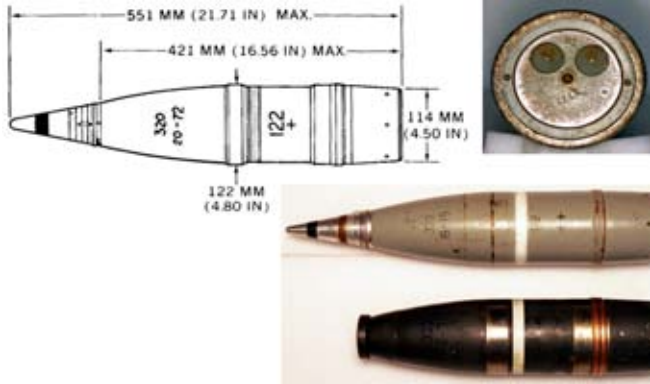

## U.S.S.R. PROJECTILE, 122-MM, ILLUM, S-463 & S-463ZH

Ordnance used with:

T-6, FUZE, PROJECTILE, TSQ

T-7, FUZE, PROJECTILE, TIME OR TSQ

T-90, PROJECTILE, MT

ZH-9, 122 MM, PROPELLING CHARGE

ZH-9, 122MM, PROPELLING CHARGE, FULL

ZH-463, 122MM, PROPELLING CHARGE



## CHINESE PROJECTILE, 130-MM, HE, AND HEI, TYPE 59

Ordnance used with:

TYPE 59, 130MM, PROPELLING CHARGE, REDUCED VA...

ZH 482U, 130MM, PROPELLING CHARGE, REDUCED

MD-11, PROJECTILE, PROX.

MD11, PROJECTILE, PROX.

MD-81

MD81, PROJECTILE, PROX.

MD-11A, PROJECTILE, PROXIMITY/PD

N.E.W. 3.64 KG

## U.S.S.R. PROJECTILE, 130 MM, ILLUM, SP-46

Ordnance used with:

TM-16L, PROJECTILE, MT

M-1954, 130MM, FIELD GUN

M46, 130MM, FIELD GUN

TYPE 59, 130MM, FIELD GUN

TYPE 59-1, 130MM, FIELD GUN

M46, 130-MM, CARTRIDGE

M46, 130MM, PROPELLING CHARGE, FULL VARIABLE

N.E.W. 780.00 G



## U.S.S.R. PROJECTILE, 130-MM, FRAG, HE, OF-482M

Ordnance used with:

TYPE 59, 130MM, PROPEL. CHARGE, REDUCED VARIABLE

ZH 482U, 130MM, PROPELLING CHARGE, REDUCED

RGM-2, PROJECTILE, PD

RGM-3, PROJECTILE, PD

RGM-6, PROJECTILE, PD

AR 7 (SIGNAL), PROJECTILE, PROXIMITY/PD

UTIU M63P2, PROJECTILE, PD

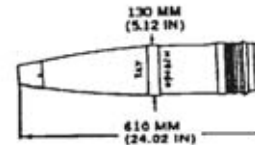

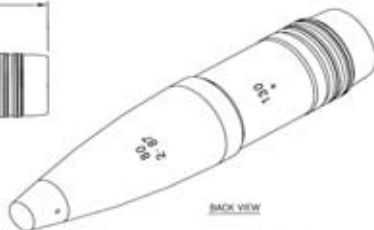
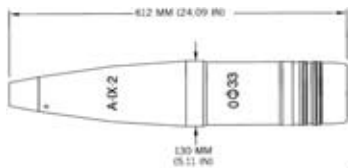

## U.S.S.R. PROJECTILE, 130-MM, FRAG, HE, OF33

Ordnance used with:  
UTIU M63P2, PROJECTILE, PD  
V-429, PROJECTILE, PD  
V-429E, PROJECTILE, PD  
B-90, PROJECTILE, MTSQ  
V-90, PROJECTILE, MTSQ  
AR 5, PROJECTILE, PROX.  
AR-5, PROJECTILE, PROX.

N.E.W. 4.30 KG

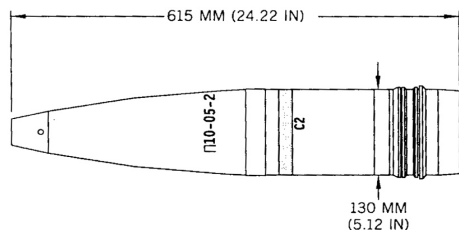

## U.S.S.R. PROJECTILE, 130-MM, ILLUMINATION, S2

Ordnance used with:  
T-90, PROJECTILE, MT  
B-90, PROJECTILE, MTSQ  
V-90, PROJECTILE, MTSQ

N.E.W. 107.00 G

## IRAQI CARTRIDGE, 100-MM, FRAG, UO-415

Ordnance used with:  
O-415, 100-MM, FRAG  
O-415, 100-MM, HE-FRAG  
KS-19M2, AIR DEFENSE GUN, 100MM  
UO-415, 100-MM, HE, FRAG (IRAQI MODEL)

N.E.W. 7.05 KG

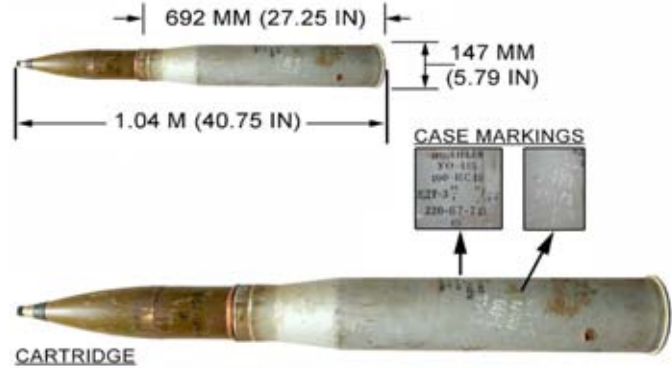

## U.S.S.R. CARTRIDGE, 100-MM, APFSDS-T, UBM-2

Ordnance used with:  
BM-2, 100-MM, APFSDS



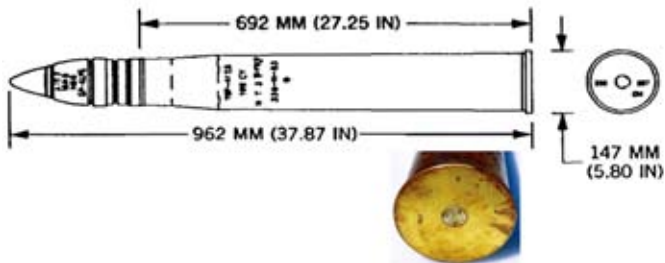

**U.S.S.R. CARTRIDGE, 100-MM, APHE OR APHE-T, UBR-412B**

Ordnance used with:  
 DBR-2, PROJECTILE, BD  
 BR-412B, 100-MM, APHE-T  
 MD-8, PROJECTILE, BD



**U.S.S.R. CARTRIDGE, 100-MM, HE, FRAG, UOF-412**

Ordnance used with:  
 NSC-1, PROJECTILE, PSD  
 OF-412, 100-MM, FRAG-HE  
 TYPE 412, PROJECTILE, 100 MM, HE  
 RGM, PROJECTILE, PD  
 RGM-2, PROJECTILE, PD  
 RGM-3, PROJECTILE, PD  
 RGM-6, PROJECTILE, PD



## U.S.S.R. CARTRIDGE, 100-MM, HEAT, UBK-2

Ordnance used with:  
GPV-2, PROJECTILE, PIBD, SPITBACK  
GPV-3, PROJECTILE, PIBD  
BK-3, 100-MM, HEAT-FS-T



## U.S.S.R. CARTRIDGE, 100-MM, HEAT-FS, UBK-4M

Ordnance used with:  
GPV-2, PROJECTILE, PIBD, SPITBACK  
3BK-5M, 100MM, HEAT-FS-T  
3BK5M, 100MM, HEAT-FS-T  
BK-5M, 100MM, HEAT-FS-T  
BK5M, 100MM, HEAT-FS-T  
ZBK-5M, 100MM, HEAT-FS-T

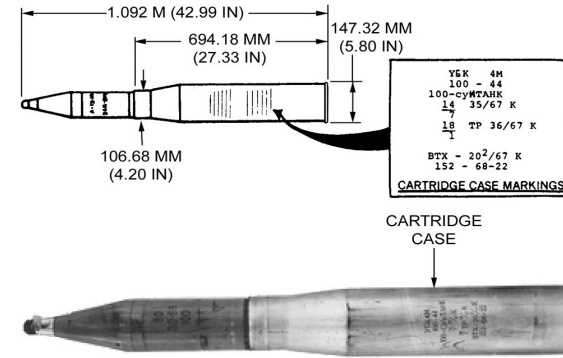

## U.S.S.R. CARTRIDGE, 122-MM, HEAT-FS-T, 3UBK-9



Ordnance used with:  
3BK-13, 122-MM, HEAT-FS-T  
BK-13, 122-MM, HEAT-FS-T  
BK13, 122-MM, HEAT-FS-T  
ZBK-13, 122-MM, HEAT-FS-T  
V-15, FUZE, PROJECTILE, PIBD  
ZH-9, 122 MM, PROPELLING CHARGE  
ZH-9, 122MM, PROPELLING CHARGE, FULL



## RUSSIAN CARTRIDGE, 100-MM, HEAT, UBK-9M

Ordnance used with:  
V-15, FUZE, PROJECTILE, PIBD  
3BK17M, 100-MM, HEAT-T  
BK-17M





## U.S.S.R. CARTRIDGE, 100-MM, APFSDS-T, UBM-8

Ordnance used with:  
BM-20, 100-MM, APFSDS

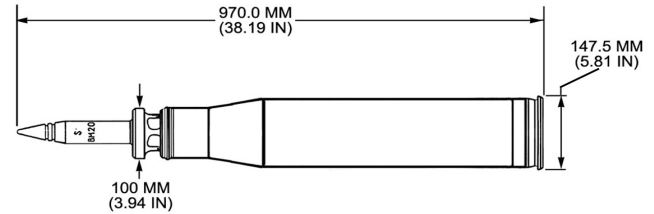

## CHINESE PROJECTILE, 152-MM, HE, TYPE 83

Ordnance used with:  
ML-7, PROJECTILE, PD  
ML7, PROJECTILE, PD

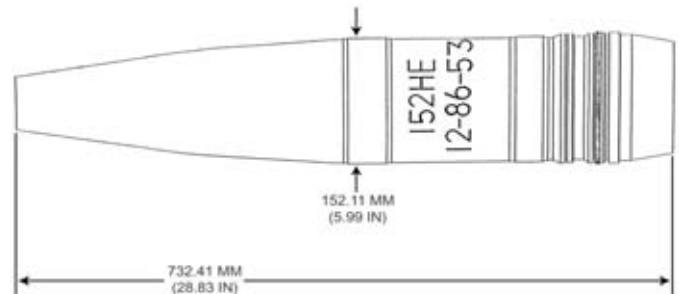

N.E.W. 6.60 KG

## RUSSIAN PROJECTILE, 152-MM, FRAG-HE, LASER-GUIDED, 3OF39 (KRASNOPOL)



IMAGES FROM RUSSIAN ARMS  
CATALOG VOL. VI, REPRODUCED  
WITH PERMISSION FROM MILITARY  
PARADE PUBLISHING HOUSE

## U.S.S.R. PROJECTILE, 152-MM, FRAG-HE, OF-530

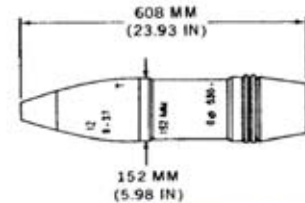

Ordnance used with:  
D-1, PROJECTILE, TSQ  
GVM, FUZE, PROJECTILE, PD  
GVMZ, FUZE, PROJECTILE, PD  
GVMZ-1, FUZE, PROJECTILE, PD  
RG-6, PROJECTILE, PD  
RGM, PROJECTILE, PD  
RGM-2, PROJECTILE, PD  
N.E.W. 6.90 KG

## U.S.S.R. PROJECTILE, 152-MM, FRAG-HE, OF-540

Ordnance used with:  
D-1, PROJECTILE, TSQ  
RGM-2, PROJECTILE, PD  
RGM-3, PROJECTILE, PD  
AR 7 (SIGNAL), PROJECTILE, PROXIMITY/PD  
UTIU M63P2, PROJECTILE, PD  
V-429, PROJECTILE, PD  
V-429E, PROJECTILE, PD

N.E.W. 5.70 KG

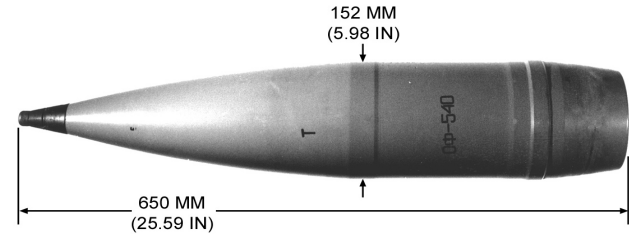

## U.S.S.R. PROJECTILE, 152-MM, HE-FRAG, OF25

Ordnance used with:  
RGM-2M, PROJECTILE, PD  
T-90, PROJECTILE, MT  
B-90, PROJECTILE, MTSQ  
V-90, PROJECTILE, MTSQ  
3OF32, 152MM, CARTRIDGE, FRAG-HE  
3VOF33, 152MM, CARTRIDGE, FRAG-HE  
NDT 3 16/1, CHARGE, PROPELLING, FULL, VARIABLE

N.E.W. 6.80 KG



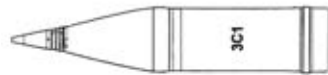

## U.S.S.R. PROJECTILE, 152-MM, ILLUMINATION, S1



Ordnance used with:  
T-90, PROJECTILE, MT

---

## U.S.S.R. PROJECTILE, 160-MM, MORTAR, HE, F-853A

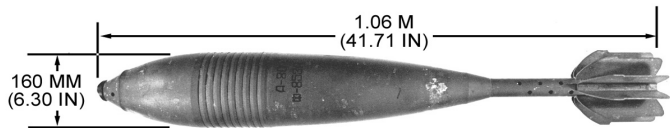

Ordnance used with:  
GVMZ-7, PROJECTILE, PD  
M-160, 160MM, MORTAR, TOWED  
TYPE 56, 160MM, MORTAR, TOWED

N.E.W. 7.73 KG

## U.S.S.R. PROJECTILE, 160-MM, MORTAR, HE, F-853U

Ordnance used with:  
GVMZ-7, PROJECTILE, PD

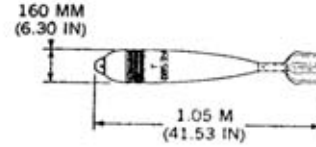

N.E.W. 8.99 KG

## U.S.S.R. CARTRIDGE, 115-MM, HE, FRAG, UOF-6

Ordnance used with:  
OF-18, 115-MM, HE-FRAG  
UTIU M63P2, PROJECTILE, PD  
V-429, PROJECTILE, PD  
V-429E, PROJECTILE, PD

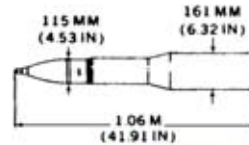

IRAQI COPY

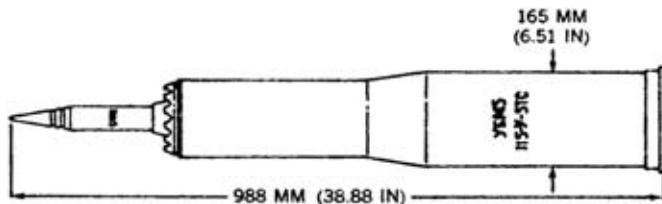

### U.S.S.R. CARTRIDGE, 115-MM, HVAP-FS-DS-T UBM-5

Ordnance used with:  
BM-6, 115-MM, APFSDS-T



### U.S.S.R. CARTRIDGE, 115-MM, FS, HEAT, UBK-3M

Ordnance used with:  
BK-4M, 115-MM, HEAT-FS  
GPV-2, PROJECTILE, PIBD, SPITBACK

N.E.W. 7.15 KG

**U.S.S.R. PROJECTILE, 240-MM, HE, MORTAR,  
GUIDED, 3F5 (SMEL'CHEK)**

Ordnance used with:  
T-90, PROJECTILE, MT  
M240, 240MM, MORTAR, TOWED  
2S4, 240MM, MORTAR, SELF-PROPELLED



N.E.W. 32.00 KG

---

**U.S.S.R. PROJECTILE, 240-MM, MORTAR, HE, F864**

Ordnance used with:  
GVMZ-7, PROJECTILE, PD  
M16, PROJECTILE, PD

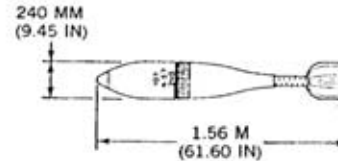

N.E.W. 31.93 KG

---

***THIS PAGE INTENTIONALLY LEFT BLANK***