

U.S.S.R. BOMB, FAB-250 M46, GENERAL PURPOSE

Ordnance used with:
APUV, NOSE & TAIL
APUVM, BOMB, NOSE & TAIL
AV 1, NOSE & TAIL
AV 1 MODIFIED, BOMB, NOSE & TAIL
AV 1D/U, BOMB, NOSE & TAIL
AVDM, TAIL
VDV, NOSE & TAIL
N.E.W. 104.00 KG



U.S.S.R. BOMB, GP, FAB-500 M54

Ordnance used with:
ADP, TAIL
APUV, NOSE & TAIL
APUV-1, NOSE & TAIL
APUVM, BOMB, NOSE & TAIL
AVDM, TAIL
AVT-E, NOSE & TAIL, IMPACT
VDV, NOSE & TAIL
N.E.W. 222.00 KG



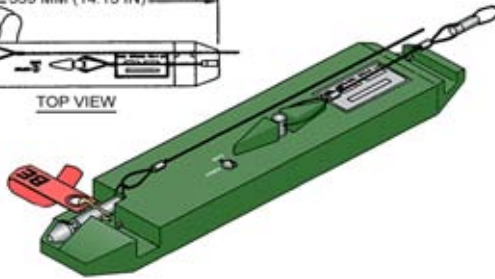
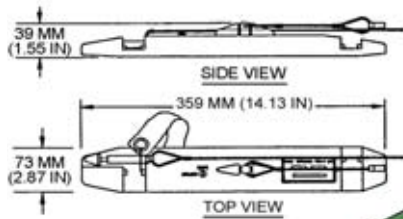

U.S. TIMER ACTUATOR, DTU-31/B

Ordnance used with:
BLU-111A/B, BOMB, GPLD, 500 LB
MK 82, 500-LB, GP

DIMENSIONS UNKNOWN



U.S.S.R. BOOSTER, INCENDIARY, PFK-ZB 250SH

Ordnance used with:
AVU-ET, NOSE/TAIL, IMPACT
AVU-ETM, BOMB FUZE
ZB-500 SH, INCENDIARY

U.S. BOMB UNITS, GUIDED, GBU-12B/B, GBU-12C/B, AND GBU-12D/B

Ordnance used with:

FMU-139/B, NOSE & TAIL, IMPACT

FMU-139A/B, NOSE & TAIL, IMPACT

FMU-26/B, BOMB FUZE, NOSE & TAIL, MULTIPURPOSE

FMU-26A/B, BOMB FUZE, NOSE & TAIL, MULTIPURPOSE

FMU-26B/B, BOMB FUZE, NOSE & TAIL, MULTIPURPOSE

FMU-81/B, BOMB FUZE, NS & TAIL, IMPACT, LG-DELAY

M905, TAIL, IMPACT

N.E.W. 88.00 KG

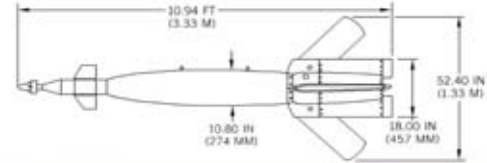

U.S. BOMB UNITS, GUIDED, GBU-12/B & GBU-12A/B

Ordnance used with:

FMU-139/B, NOSE & TAIL, IMPACT

FMU-139A/B, NOSE & TAIL, IMPACT

FMU-26/B, BOMB FUZE, NOSE & TAIL, MULTIPURPOSE

FMU-26A/B, BOMB FUZE, NOSE & TAIL, MULTIPURPOSE

FMU-26B/B, BOMB FUZE, NOSE & TAIL, MULTIPURPOSE

FMU-81/B, BOMB FUZE, NS & TAIL, IMPACT, SRT-DELAY

M905, TAIL, IMPACT

N.E.W. 88.00 KG

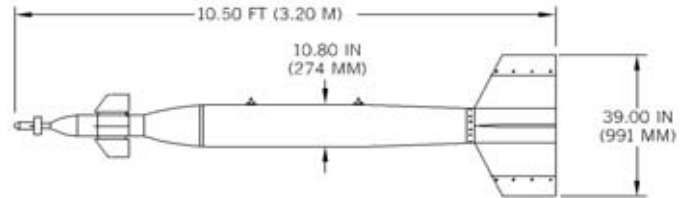

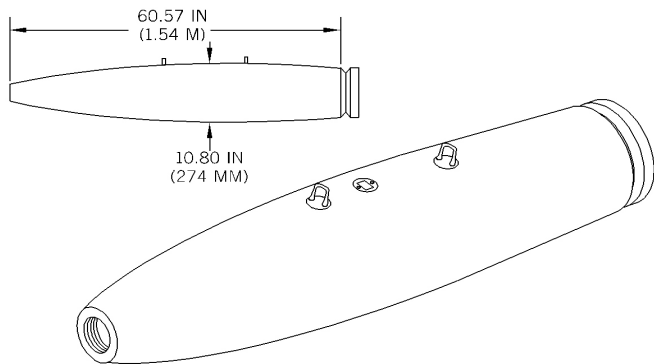

U.S. BOMB, 500-LB, GP (LOW DRAG), BLU-111A/B

Ordnance used with:
 DSU-33A(D-2)/B, SENSING ELEMENT, DUMMY
 DSU-33A/B, SENSING ELEMENT, PROX.
 FMU-139/B, NOSE & TAIL, IMPACT
 FMU-139A/B, NOSE & TAIL, IMPACT
 FMU-26/B, BOMB FUZE, NOSE & TAIL, MULTIPURPOSE
 FMU-26A/B, BOMB FUZE, NOSE & TAIL, MULTIPURPOSE
 FMU-26B/B, BOMB FUZE, NOSE & TAIL, MULTIPURPOSE

N.E.W. 87.10 KG

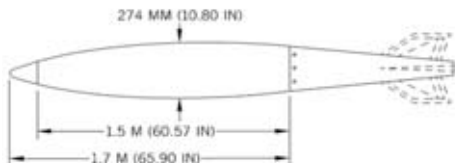

U.S. BOMB, 500-LB, GP (LOW DRAG), MK 82

Ordnance used with:
 AN-M166, NOSE, PROX.
 BSU-49/B, FIN ASSEMBLY, AIR INFLATABLE RETARDER
 BSU-86/B, FIN
 DSU-30/B, BOMB TARGET DETECTING DEVICE
 DSU-33A(D-2)/B, SENSING ELEMENT, DUMMY
 DSU-33A/B, SENSING ELEMENT, PROX.
 FMU-112/B, BOMB FUZE, NOSE & TAIL

N.E.W. 87.10 KG

U.S.S.R. BOMB, PHOTOFLASH, FOTAB-100-80

Ordnance used with:
AGDT A, BOMB, NOSE
AGDT B, BOMB, NOSE
TM-24A, BOMB, NOSE OR TAIL

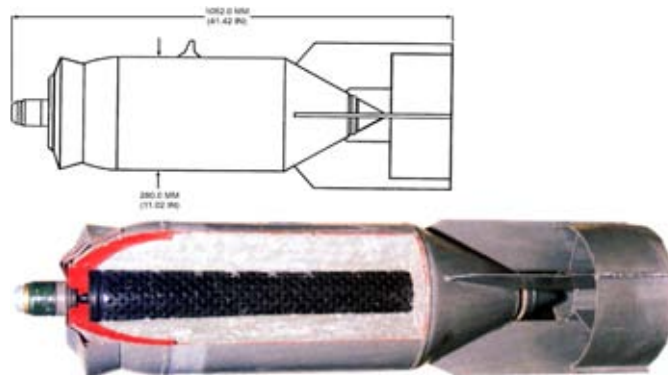

U.S.S.R. BOMB, PHOTOFLASH, FOTAB-250T



U.S.S.R. BOMB, 250-KG, HE, FAB-250 M62

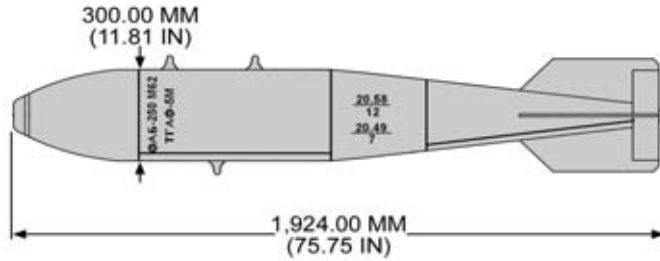

Ordnance used with:
AVU-E, NOSE & TAIL
VDV-1, NOSE & TAIL
VDV 2, BOMB, NOSE & TAIL

N.E.W. 107.00 KG

U.S.S.R. BOMB, FRAG HE, OFAB 250 SHN



Ordnance used with:
AVU-529

N.E.W. 93.70 KG

U.S.S.R. BOMB, FRAG, HE, 250-KG, OFAB-250-270

Ordnance used with:
AM B, BOMB, NOSE
AM B B/V, BOMB, NOSE
APUV-1, NOSE & TAIL
VDV, NOSE & TAIL
VDV-1, NOSE & TAIL
VDV 2, BOMB, NOSE & TAIL
AVU-ET, NOSE/TAIL, IMPACT
N.E.W. 94.00 KG

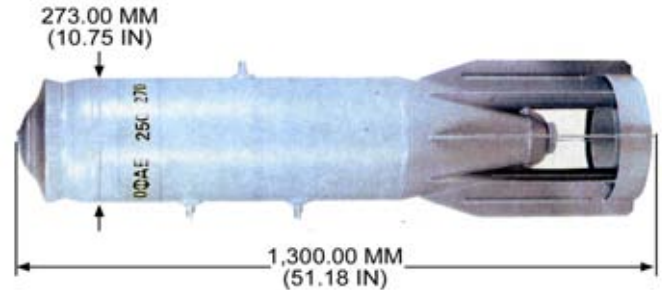

U.S.S.R. BOMB, ILLUMINATION, SAB-250-200



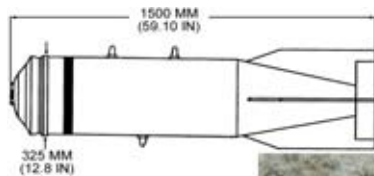

U.S.S.R. BOMB, INCENDIARY, ZAB 250-200

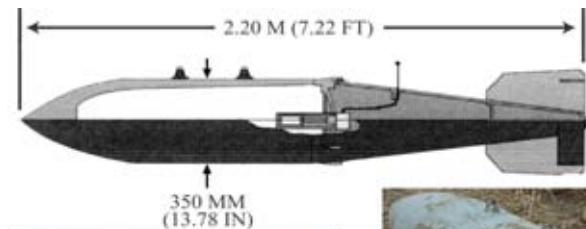

**U.S.S.R. BOMB, 478-KG, TARGET PENETRATION,
BETAB-500**

N.E.W. 75.80 KG

U.S. BOMB UNITS, GUIDED, GBU-16/B, GBU-16A/B, AND GBU-16B/B

Ordnance used with:

FMU-124A/B, NOSE & TAIL, IMPACT

FMU-139/B, NOSE & TAIL, IMPACT

FMU-139A/B, NOSE & TAIL, IMPACT

FMU-26/B, BOMB FUZE, NOSE & TAIL, MULTIPURPOSE

FMU-26A/B, BOMB FUZE, NOSE & TAIL, MULTIPURPOSE

FMU-26B/B, BOMB FUZE, NOSE & TAIL, MULTIPURPOSE

FMU-81/B, BOMB FUZE, NS & TAIL, IMPACT, LG-DELAY

N.E.W. 203.00 KG

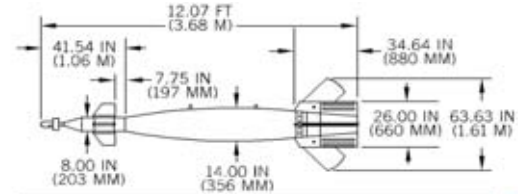

U.S. BOMB, 1000-LB, GP (LOW DRAG), BLU-110A/B

Ordnance used with:

DSU-33A(D-2)/B, SENSING ELEMENT, DUMMY

DSU-33A/B, SENSING ELEMENT, PROX.

FMU-139/B, NOSE & TAIL, IMPACT

FMU-139A/B, NOSE & TAIL, IMPACT

FMU-26/B, BOMB FUZE, NOSE & TAIL, MULTIPURPOSE

FMU-26A/B, BOMB FUZE, NOSE & TAIL, MULTIPURPOSE

FMU-26B/B, BOMB FUZE, NOSE & TAIL, MULTIPURPOSE

N.E.W. 202.00 KG

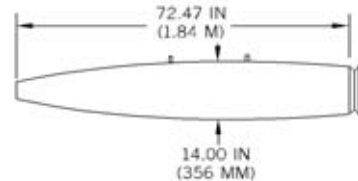

U.S. BOMB, 1000-LB, GP (LOW DRAG), MK 83

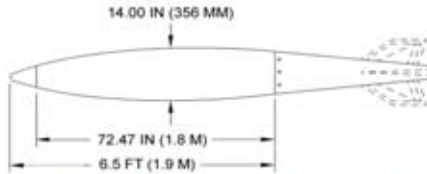

Ordnance used with:
BSU-85/B, BOMB FIN ASSY, AIR INFLATABLE RETARDER
DSU-30/B, BOMB TARGET DETECTING DEVICE
DSU-33A(D-2)/B, SENSING ELEMENT, DUMMY
DSU-33A/B, SENSING ELEMENT, PROX.
FMU-112/B, BOMB FUZE, NOSE & TAIL
FMU-113/B, PROX.
FMU-124A/B, NOSE & TAIL, IMPACT
N.E.W. 202.00 KG

U.S. BOMB UNIT, GUIDED, GBU-24A/B

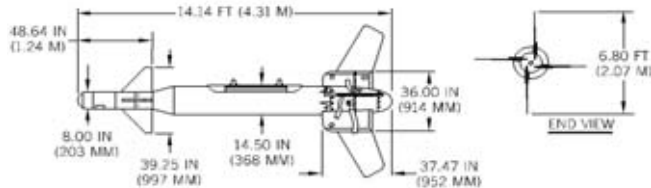

Ordnance used with:
BLU-109/B, PENETRATOR
FMU-143/B, BOMB FUZE, NOSE & TAIL, IMPACT
FMU-143A/B, BOMB FUZE, NOSE & TAIL, IMPACT
FMU-143B/B, NOSE & TAIL, IMPACT
FMU-143D/B, BOMB FUZE, NOSE & TAIL, IMPACT
FMU-143E/B, NOSE & TAIL, IMPACT
FMU-143F/B, NOSE & TAIL, IMPACT
N.E.W. 243.00 KG

U.S. BOMB UNIT, GUIDED, GBU-24B/B

Ordnance used with:
BLU-109A/B, PENETRATOR
FMU-143E/B, NOSE & TAIL, IMPACT
FZU-32B/B, INITIATOR
ADU-770/B, ADAPTER GROUP
WGU-39B/B, GUIDANCE & CTRL. GROUP
BSU-84A/B, AIRFOIL GROUP
BLU-109/B BOMB PENETRATION

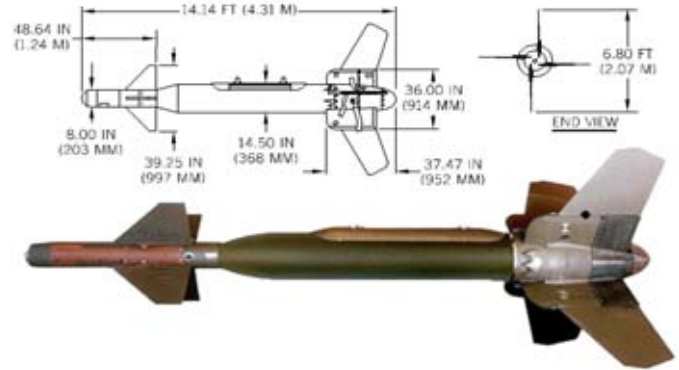

U.S. BOMB UNIT, GUIDED, GBU-27/B

Ordnance used with:
BLU-109/B, PENETRATOR
FMU-124A/B, NOSE & TAIL, IMPACT
FMU-139/B, NOSE & TAIL, IMPACT
FMU-139A/B, NOSE & TAIL, IMPACT
FMU-143/B, BOMB FUZE, NOSE & TAIL, IMPACT
FMU-143B/B, NOSE & TAIL, IMPACT
FMU-81/B, BOMB FUZE, NOSE & TAIL, IMPACT, SHO...
N.E.W. 243.00 KG

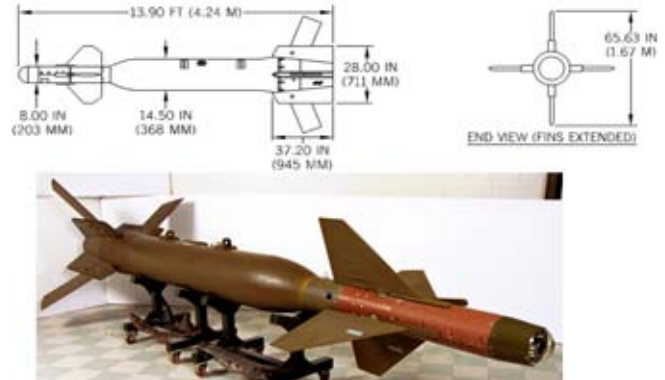

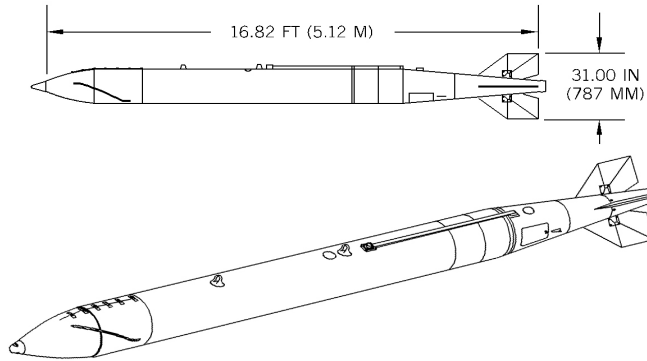

U.S. BOMB UNIT, GUIDED, GBU-37/B

Ordnance used with:
BLU-113/B, PENETRATOR
BLU-113A/B, PENETRATOR
FZU-32B/B, INITIATOR

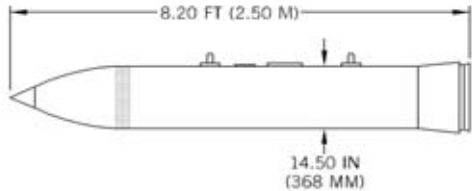

U.S. BOMB UNIT, PENETRATOR, BLU-109/B

Ordnance used with:
FMU-143/B, BOMB FUZE, NOSE & TAIL, IMPACT
FMU-143A/B, BOMB FUZE, NOSE & TAIL, IMPACT
FMU-143E/B, NOSE & TAIL, IMPACT
GBU-10G/B, BOMB UNIT, GUIDED
GBU-10H/B, BOMB UNIT, GUIDED
GBU-10J/B, BOMB UNIT, GUIDED
GBU-15(V)2/B



N.E.W. 243.00 KG

U.S. BOMB UNIT, PENETRATOR, BLU-109A/B

Ordnance used with:
FMU-143E/B, NOSE & TAIL, IMPACT
GBU-10G/B, BOMB UNIT, GUIDED
GBU-10H/B, BOMB UNIT, GUIDED
GBU-10J/B, BOMB UNIT, GUIDED
GBU-24B/B, BOMB UNIT, GUIDED
GBU-31(V)3/B, GUIDED BOMB UNIT, JDAM
GBU-31(V)4/B, GUIDED BOMB UNIT (JDAM)
N.E.W. 243.00 KG

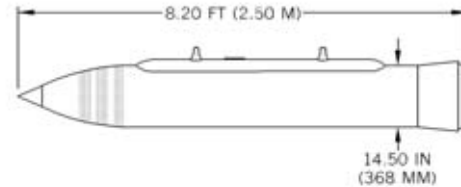

U.S. BOMB UNITS, GBU-28/B AND GBU-28A/B

Ordnance used with:
BLU-113/B, PENETRATOR
BLU-113A/B, PENETRATOR
FMU-143F/B, NOSE & TAIL, IMPACT
FMU-143G/B, NOSE & TAIL, IMPACT
FMU-143H/B, NOSE & TAIL, IMPACT
FZU-48/B, INITIATOR
FZU-32B/B, INITIATOR

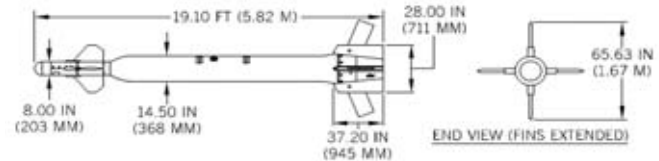

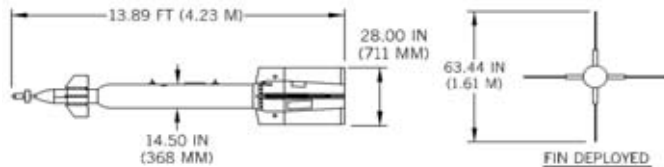

U.S. BOMB UNITS, GUIDED, GBU-10G/B, H/B, & J/B

Ordnance used with:
 BLU-109/B, PENETRATOR
 BLU-109A/B, PENETRATOR
 FMU-139A/B, NOSE & TAIL, IMPACT
 FMU-143/B, BOMB FUZE, NOSE & TAIL, IMPACT
 FMU-143B/B, NOSE & TAIL, IMPACT
 MAU-169/B, COMPUTER CTRL. (CCG)

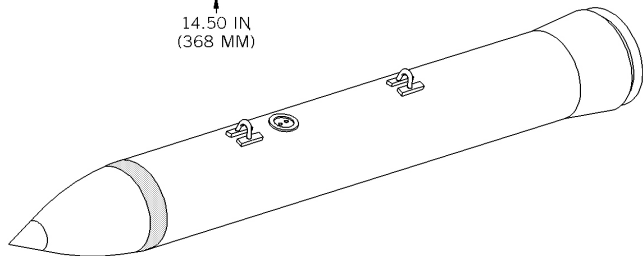
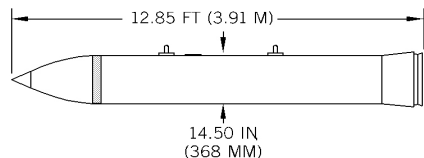

U.S. BOMB UNITS, PENETRATOR, BLU-113/B AND BLU-113A/B

Ordnance used with:
 FMU-143F/B, NOSE & TAIL, IMPACT
 FMU-143G/B, NOSE & TAIL, IMPACT
 FMU-143H/B, NOSE & TAIL, IMPACT
 GBU-28/B
 GBU-28A/B
 GBU-37/B, GUIDED BOMB UNIT
 FZU-48/B, INITIATOR
 N.E.W. 299.00 KG

U.S. BOMB, 2000-LB, PENETRATOR, BLU-118, THERMOBARIC

Ordnance used with:
FMU-143J/B, NOSE & TAIL, IMPACT
GBU-24H/B, GUIDED UNIT

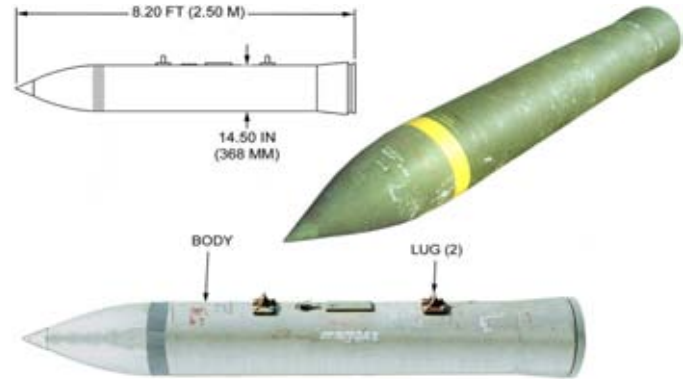

N.E.W. 272.00 KG

U.S.S.R. BOMB, 500-KG, GP, FAB-500, M62

Ordnance used with:
VDV, NOSE & TAIL
AVU-ET, NOSE/TAIL, IMPACT
AVU, BOMB, NOSE

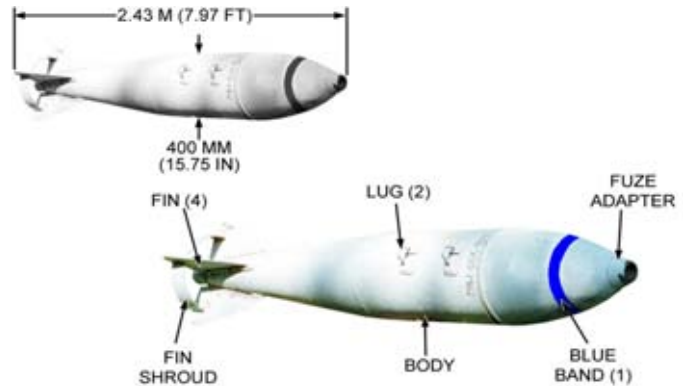

N.E.W. 213.00 KG

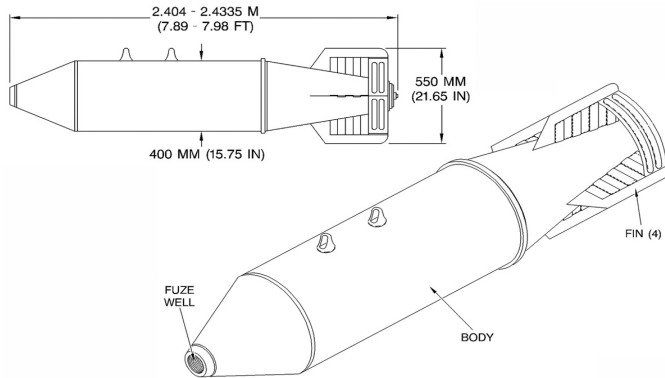

U.S.S.R. BOMB, LEAFLET, AGITAB-500-300

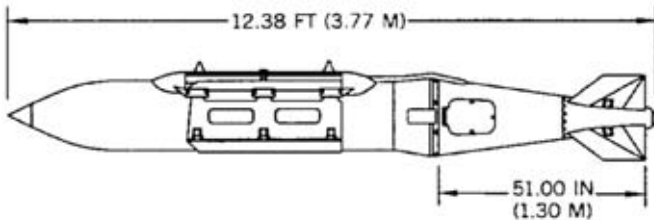

U.S. BOMB UNITS, GUIDED, GBU-31(V)3/B AND GBU-31(V)4/B (JDAM)



Ordnance used with:
 BLU-109/B, PENETRATOR
 BLU-109A/B, PENETRATOR
 FMU-143B/B, NOSE & TAIL, IMPACT
 FMU-143E/B, NOSE & TAIL, IMPACT
 FZU-55/B
 FZU-32B/B, INITIATOR
 KMU-557/B, GUIDANCE SET
 N.E.W. 539.00 LB

U.S. BOMB, 750-LB, GP, M117

Ordnance used with:
AN-M166, NOSE, PROX.
BSU-85/B, BOMB FIN ASSY, AIR INFLATABLE RETARDER
BSU-93/B, FIN ASSEMBLY, AIR INFLATABLE RETARDER
DSU-30/B, BOMB TARGET DETECTING DEVCE
DSU-33A(D-2)/B, SENSING ELEMENT, DUMMY
DSU-33A/B, SENSING ELEMENT, PROX.
FMU-112/B, BOMB FUZE, NOSE & TAIL

N.E.W. 175.00 KG

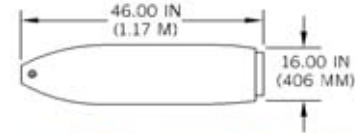

U.S. BOMB, 750-LB, GP, M117A1

Ordnance used with:
AN-M166, NOSE, PROX.
BSU-85/B, BOMB FIN ASSY, AIR INFLATABLE RETARDER
BSU-93/B, FIN ASSEMBLY, AIR INFLATABLE RETARDER
DSU-30/B, BOMB TARGET DETECTING DEVCE
DSU-33A(D-2)/B, SENSING ELEMENT, DUMMY
DSU-33A/B, SENSING ELEMENT, PROX.
FMU-112/B, BOMB FUZE, NOSE & TAIL

N.E.W. 176.00 KG

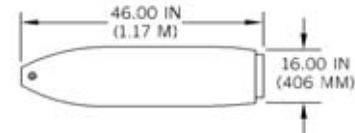

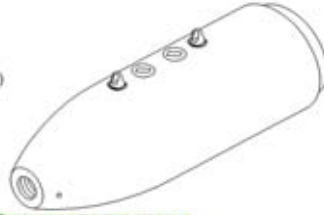
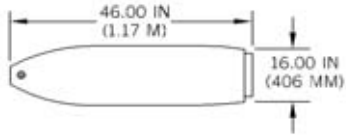

U.S. BOMBS, 750-LB, GP, M117A1E1, M117A1E2, M117A1E3, M117A2 AND M117A3

Ordnance used with:

AN-M166, NOSE, PROX.

BSU-85/B, BOMB FIN ASSY, AIR INFLATABLE RETARDER

BSU-93/B, FIN ASSEMBLY, AIR INFLATABLE RETARDER

DSU-30/B, BOMB TARGET DETECTING DEVICE

DSU-33A(D-2)/B, SENSING ELEMENT, DUMMY

DSU-33A/B, SENSING ELEMENT, PROX.

FMU-112/B, BOMB FUZE, NOSE & TAIL

N.E.W. 172.00 KG

U.S.S.R. BOMB, 500-KG, GP, FAB-500 SHN

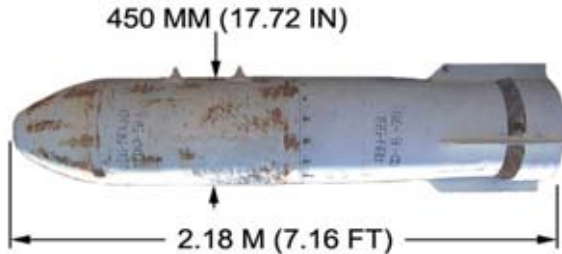

Ordnance used with:

UP-581, BOMB, FUZE

AVU-551, BOMB FUZE, TAIL

U.S.S.R. BOMB, 1100-LB, GP, WELDED, FAB-500

Ordnance used with:
AGP, BOMB, NOSE
APUV, NOSE & TAIL
APUV-1, NOSE & TAIL
APUVM, BOMB, NOSE & TAIL
AVU-E, NOSE & TAIL
VDV, NOSE & TAIL
AV 2 D/U, BOMB FUZE, NOSE & TAIL

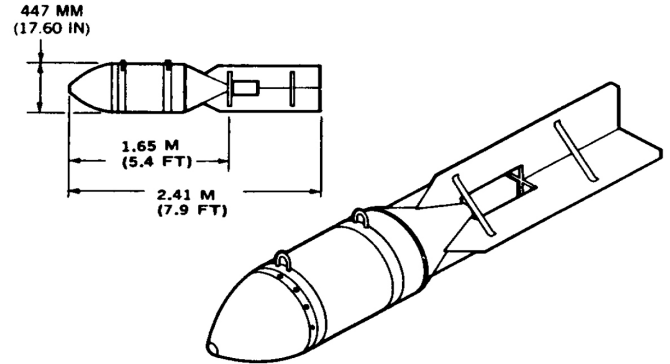

U.S.S.R. BOMB, 500-KG, HE, PARACHUTE RETARDED, FAB-500SHL



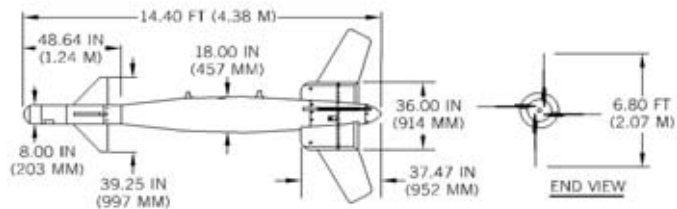

U.S. BOMB UNIT, GUIDED, GBU-24/B

Ordnance used with:

- FMU-139/B, NOSE & TAIL, IMPACT
- FMU-139A/B, NOSE & TAIL, IMPACT
- FMU-143/B, BOMB FUZE, NOSE & TAIL, IMPACT
- FMU-143A/B, BOMB FUZE, NOSE & TAIL, IMPACT
- FMU-143B/B, NOSE & TAIL, IMPACT
- FMU-143D/B, BOMB FUZE, NOSE & TAIL, IMPACT
- FMU-143E/B, NOSE & TAIL, IMPACT

N.E.W. 430.00 KG

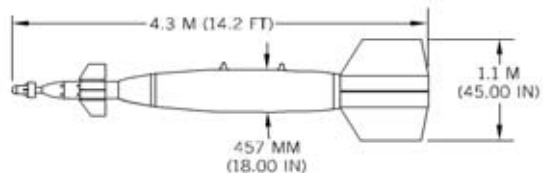

U.S. BOMB UNITS, GUIDED, GBU-10/B & GBU-10A/B

Ordnance used with:

- FMU-139/B, NOSE & TAIL, IMPACT
- FMU-139A/B, NOSE & TAIL, IMPACT
- FMU-26/B, BOMB FUZE, NOSE & TAIL, MULTIPURPOSE
- FMU-26A/B, BOMB FUZE, NOSE & TAIL, MULTIPURPOSE
- FMU-26B/B, BOMB FUZE, NOSE & TAIL, MULTIPURPOSE
- FMU-81/B, BOMB FUZE, NS & TAIL, IMPACT, SRT-DELAY M905, TAIL, IMPACT

N.E.W. 430.00 KG

U.S. BOMB UNITS, GUIDED, GBU-10C/B, D/B, AND E/B

Ordnance used with:

FMU-139/B, NOSE & TAIL, IMPACT

FMU-139A/B, NOSE & TAIL, IMPACT

FMU-143/B, BOMB FUZE, NOSE & TAIL, IMPACT

FMU-143B/B, NOSE & TAIL, IMPACT

FMU-26B/B, BOMB FUZE, NOSE & TAIL, MULTIPURPOSE

FMU-81/B, BOMB FUZE, NS & TAIL, IMPACT, SRT-DELAY

M905, TAIL, IMPACT

N.E.W. 430.00 KG

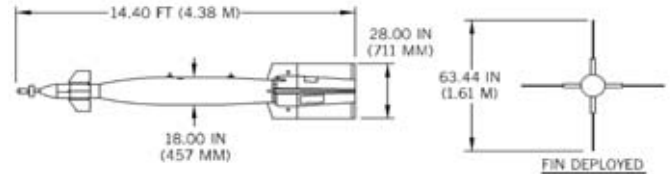

U.S. BOMB UNITS, GUIDED, GBU-31(V)1/B AND GBU-31(V)2/B (JDAM)

Ordnance used with:

DSU-33A/B, SENSING ELEMENT, PROX.

FMU-139A/B, NOSE & TAIL, IMPACT

DSU-33B/B, SENSING ELEMENT, PROX.

FMU-139B/B, BOMB, NOSE/TAIL

MK 84, 2000-LB, GP

BLU-117A/B, GENERAL PURPOSE, 2,000-LB,

FZU-48/B, INITIATOR

N.E.W. 945.00 LB

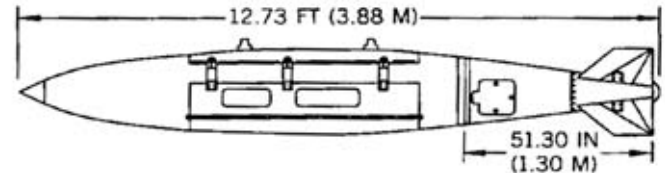

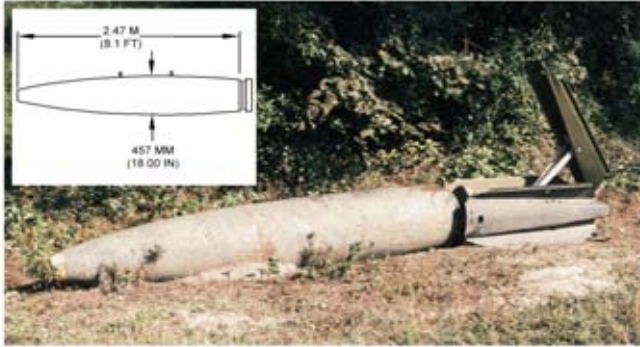

U.S. BOMB, 2000-LB, GP (LOW DRAG), MK 84

Ordnance used with:

AN-M166, NOSE, PROX.

BSU-50/B, FIN ASSEMBLY, AIR INFLATABLE RETARDER

DSU-30/B, BOMB TARGET DETECTING DEVICE

DSU-33A(D-2)/B, SENSING ELEMENT, DUMMY

DSU-33A/B, SENSING ELEMENT, PROX.

FMU-112/B, BOMB FUZE, NOSE & TAIL

FMU-113/B, PROX.

N.E.W. 429.00 KG

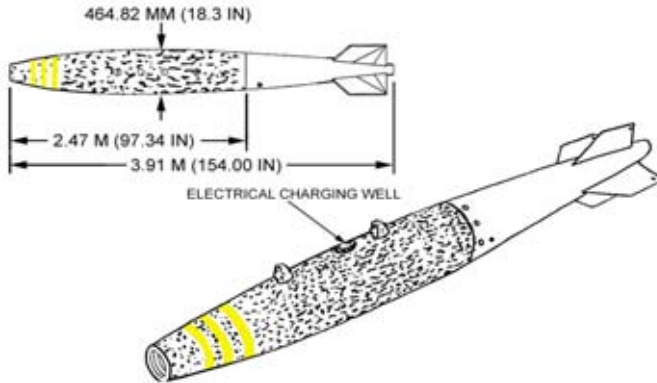

U.S. BOMB, 2000-LB, GP, BLU-117A/B

Ordnance used with:

FMU-139/B, NOSE & TAIL, IMPACT

FMU-139A/B, NOSE & TAIL, IMPACT

GBU-10/B, BOMB UNIT, GUIDED

GBU-10A/B, BOMB UNIT, GUIDED

GBU-10C/B, BOMB UNIT, GUIDED

GBU-10D/B, BOMB UNIT, GUIDED

GBU-10E/B, BOMB UNIT, GUIDED

N.E.W. 901.00 LB

U.S.S.R. BOMB, 500-KG, FAE, ODAB-500PM



"Image from Russian Arms Catalog, Vol. #VII, reproduced with Permission from Military Parade Publishing House."

N.E.W. 193.00 KG

U.S.S.R. BOMB, 500-KG, INCENDIARY, ZB-500 SH

Ordnance used with:
PF.K ZB-500SH, BOOSTER, INCENDIARY

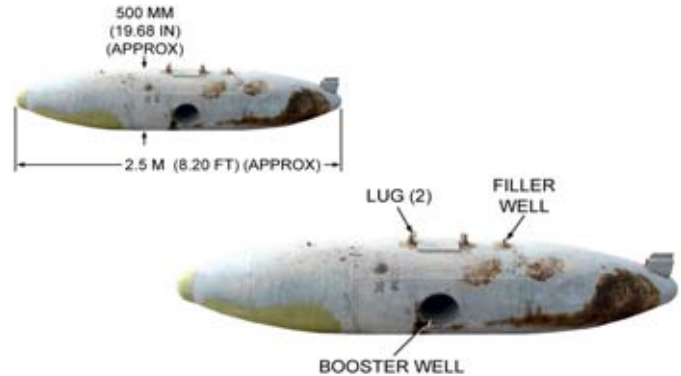

U.S.S.R. BOMB, INCENDIARY, ZB 500 GD

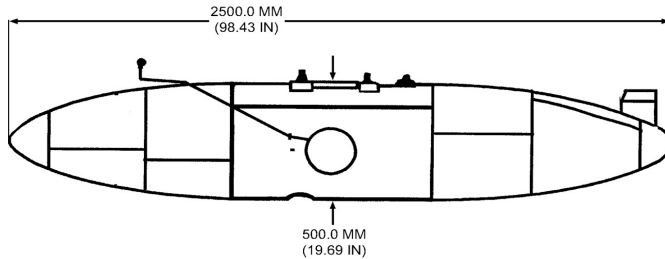

U.S.S.R. BOMB UNIT, GUIDED, 1,500-KG, HE, KAB-1500KR



Ordnance used with:
UNKNOWN, BOMB, HE, 1500 KG
SEEKER, TV GUIDED, KAB-1500
CTRL. SECTION KAB-1500KR

IMAGE FROM RUSSIAN ARMS CATALOG, VOLUME VII, REPRODUCED WITH PERMISSION FROM MILITARY PARADE PUBLISHING HOUSE.

U.S.S.R. BOMB UNIT, GUIDED, HE-FRAG, KAB-1500L-F

Ordnance used with:
UNKNOWN, COMPUTER CTRL. GROUP
UNKNOWN, WING ASSY.

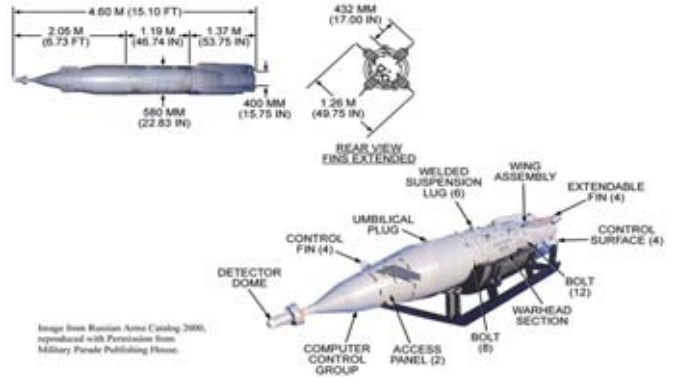

N.E.W. 1180.00 KG

U.S. BOMB UNIT, BLAST, CRADLED, 15,000-LB, BLU-82/B

Ordnance used with:
M904E1, NOSE
M904E2, NOSE
M904E3, NOSE
M904E4, NOSE
M905, TAIL, IMPACT
M.905, TAIL, IMPACT
T771E4, TAIL, IMPACT

N.E.W. 5717.84 KG

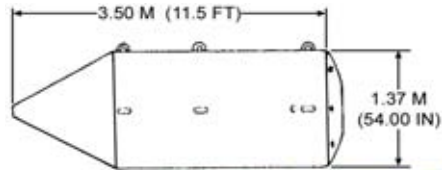

THIS PAGE INTENTIONALLY LEFT BLANK