

**BULGARIAN CARTRIDGE, 73-MM, ROCKET, HEAT,
PG-15V**

Ordnance used with:

PG-9, 73MM, HEAT

VP-9 G CH, ROCKET, PI ELEMENT

MDL. UNKNOWN, PG-9, 73MM, RKT MOTOR

PG-15P, 73MM, PROPELLING CHARGE

UNDESIGNATED, WARHEAD, 73MM, HEAT, FOR PG-9

VP-9 D CH, ROCKET, BD ELEMENT



**BULGARIAN CARTRIDGE, 73-MM, ROCKET, HEAT,
PG-15VN**

Ordnance used with:

PG-9N, 73MM, HEAT

VP-9 G CH, ROCKET, PI ELEMENT

MDL. UNKNOWN, PG-9, 73MM, RKT MOTOR

PG-15P, 73MM, PROPELLING CHARGE

PG-9N, WARHEAD, 73-MM, HEAT

VP-9 D CH, ROCKET, BD ELEMENT



**BULGARIAN CARTRIDGE, 73-MM, ROCKET, HEAT,
PG-9V**



Ordnance used with:
PG-9, 73MM, HEAT
VP-9 G CH, ROCKET, PI ELEMENT
MDL. UNKNOWN, PG-9, 73MM, RKT MOTOR
346 E, 73MM, PROPELLING CHARGE
PG-9P, 73MM, EXPELLING CHARGE
PG-9P, 73MM, PROPELLING CHARGE
UNDESIGNATED, WARHEAD, 73MM, HEAT, FOR PG-9

**BULGARIAN CARTRIDGE, 73-MM, ROCKET, HEAT,
PG-9VN**



Ordnance used with:
PG-9N, 73MM, HEAT
VP-9 G CH, ROCKET, PI ELEMENT
MDL. UNKNOWN, PG-9, 73MM, RKT MOTOR
346 E, 73MM, PROPELLING CHARGE
PG-9P, 73MM, EXPELLING CHARGE
PG-9P, 73MM, PROPELLING CHARGE
PG-9N, WARHEAD, 73-MM, HEAT

BULGARIAN PROPELLING CHARGE, ROCKET CARTRIDGE, 73-MM, PG-15P

Ordnance used with:

PG-15V, CARTRIDGE, 73MM, HEAT

PG-9, 73MM, HEAT

PG-15VN, CARTRIDGE, 73MM, HEAT

PG-9N, 73MM, HEAT

MDL. UNKNOWN, PG-9, 73MM, RKT MOTOR

PG-9, 73MM, PRACTICE

PG-15, CARTRIDGE, 73-MM, PRAC



BULGARIAN ROCKET, 73-MM, HEAT, PG-9N

Ordnance used with:

PG-15VN, CARTRIDGE, 73MM, HEAT

VP-9 G CH, ROCKET, PI ELEMENT

MDL. UNKNOWN, PG-9, 73MM, RKT MOTOR

PG-9VN, 73MM, CARTRIDGE, ROCKET, HEAT

346 E, 73MM, PROPELLING CHARGE

PG-9P, 73MM, EXPELLING CHARGE

PG-9P, 73MM, PROPELLING CHARGE





CHINESE ROCKET, 85MM, HEAT, TYPE 69-I W/TYPE 1 FUZE

Ordnance used with:
TYPE 1, ROCKET, PIBD



BULGARIAN ROCKET EXPPELLING CHARGE, PG-7P



Ordnance used with:
PG-7VL, 93MM, HEAT-T



CHINESE EXPELLING CHARGE, MODEL UNKNOWN (FOR PG-9 TYPE)

Ordnance used with:
TYPE 69-1, 85-MM, HEAT
TYPE 69-1, 85MM, HEAT



U.S.S.R. ROCKET WARHEAD, 57-MM, HE-FRAG, S-5MO

Ordnance used with:
UB-16-57, UMVP, LAUNCHER, ROCKET, AIRCRAFT
UB-32A1, LAUNCHER, ROCKET, AIRCRAFT (57-MM)
V-5K, ROCKET, PD, A-TO-S
C-5MO, 57-MM, HE/FRAG, A-TO-S
S-5MO, 57-MM, HE/FRAG, A-TO-S
S-5MO, MOTOR, 57 MM, SOLID PROPELLENT, A-TO-S

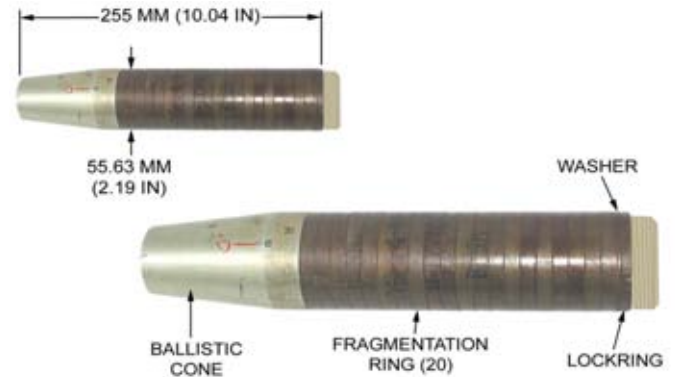



U.S.S.R. ROCKET MOTOR, 57-MM, SOLID PROPELLANT, AIR-TO-SURFACE, S-5KO

Ordnance used with:
UB-16-57, UMVP, LAUNCHER, ROCKET, AIRCRAFT
UB-32A1, LAUNCHER, ROCKET, AIRCRAFT (57-MM)
S-5KO, 57-MM, WARHEAD, HEAT-FRAG, A-TO-S

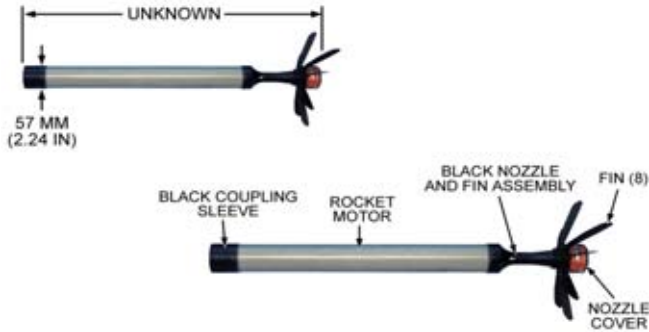

U.S.S.R. ROCKET MOTOR, 57-MM, SOLID PROPELLANT, MODEL UNKNOWN

Ordnance used with:
S-5-OB, 57-MM, WARHEAD, ILLUMINATION, A-TO-S
S-5-01, 57-MM, ILLUMINATION, A-TO-S
S-5-OB, 57-MM, ILLUMINATION, A-TO-S

"Image from the Russian Arms Catalog,
Vol. VII, reproduced with permission from
Military Parade Publishing House."

U.S.S.R. ROCKET MOTOR, 57-MM, SOLID PROPELLANT, S-5KP

Ordnance used with:

UB-16-57, UMVP, LAUNCHER, ROCKET, AIRCRAFT
UB-32A1, LAUNCHER, ROCKET, AIRCRAFT (57-MM)
S-5KP, 57-MM, HEAT/FRAG, A-TO-S
S-5KP, 57-MM, WARHEAD, HEAT/FRAG, A-TO-S



U.S.S.R. ROCKET MOTOR, 57-MM, SOLID-PROPELLANT, S-5MO

Ordnance used with:

UB-16-57, UMVP, LAUNCHER, ROCKET, AIRCRAFT
UB-32A1, LAUNCHER, ROCKET, AIRCRAFT (57-MM)
C-5MO, 57-MM, HE/FRAG, A-TO-S
S-5MO, 57-MM, HE/FRAG, A-TO-S
S-5MO, 57-MM, WARHEAD, HEAT/FRAG, A-TO-S

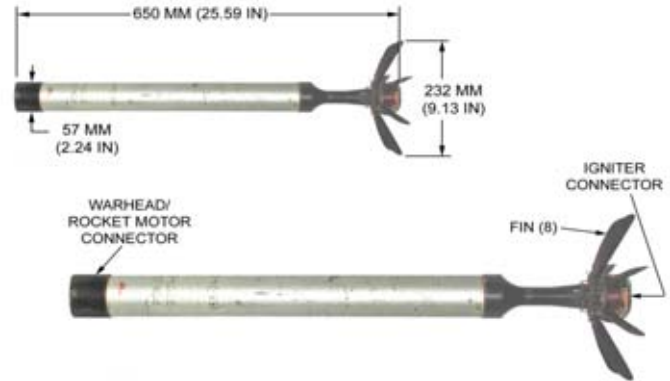

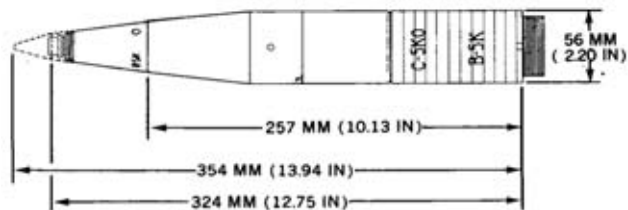

U.S.S.R. ROCKET WARHEAD, 57-MM, HEAT/FRAG MODEL S-5KO

Ordnance used with:
 UB-16-57, UMVP, LAUNCHER, ROCKET, AIRCRAFT
 UB-32A1, LAUNCHER, ROCKET, AIRCRAFT (57-MM)
 V-5K, ROCKET, PD, A-TO-S
 V-5M1, ROCKET, PDSD
 KO-7V, 57MM, CARTRIDGE, HEAT-FRAG

U.S.S.R. ROCKET WARHEAD, 57-MM, HEAT/FRAG, S-5KP



Ordnance used with:
 UB-16-57, UMVP, LAUNCHER, ROCKET, AIRCRAFT
 UB-32A1, LAUNCHER, ROCKET, AIRCRAFT (57-MM)
 S-5KP, 57-MM, HEAT/FRAG, A-TO-S
 S-5KP, MOTOR, 57-MM, SOLID PROPELLANT, A-TO-S
 V-5KP1, ROCKET, PIBD, A-TO-S

U.S.S.R. ROCKET, 57-MM, AIR-TO-SURFACE, HEAT/ FRAG, S-5KP

Ordnance used with:

UB-16-57, UMVP, LAUNCHER, ROCKET, AIRCRAFT
UB-32A1, LAUNCHER, ROCKET, AIRCRAFT (57-MM)
UB-32A, LAUNCHER, ROCKET, AIRCRAFT (57-MM)
S-5KP, 57-MM, WARHEAD, HEAT/FRAG, A-TO-S
S-5KP, MOTOR, 57-MM, SOLID PROPELLANT, A-TO-S
V-5KP1, ROCKET, PIBD, A-TO-S

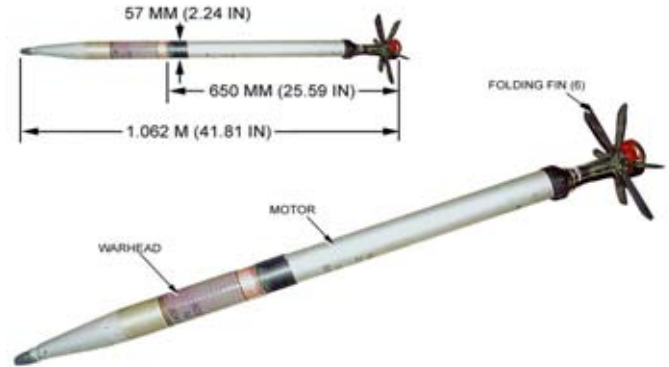

U.S.S.R. ROCKET, 57-MM, CHAFF, S-5PB

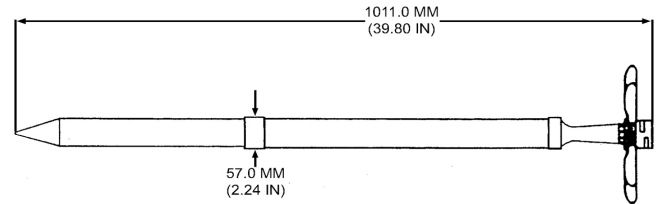



U.S.S.R. ROCKET, 57-MM, HE, S-5M

Ordnance used with:

UB-16-57, UMVP, LAUNCHER, ROCKET, AIRCRAFT
 UB-32A1, LAUNCHER, ROCKET, AIRCRAFT (57-MM)
 UB-32A, LAUNCHER, ROCKET, AIRCRAFT (57-MM)
 UB-16-57-U, 57-MM, LAUNCHER, RKT
 V-5M1, ROCKET, PDS
 UB-16-57-U, 57 MM, LAUNCHER, ROCKET, 16 SHOT

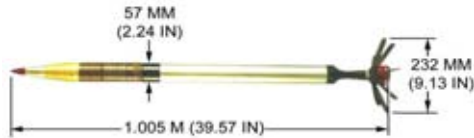

U.S.S.R. ROCKET, 57-MM, HE-FRAG, S-5MO

Ordnance used with:

UB-16-57, UMVP, LAUNCHER, ROCKET, AIRCRAFT
 UB-32A1, LAUNCHER, ROCKET, AIRCRAFT (57-MM)
 V-5K, ROCKET, PD, A-TO-S
 V-5M1, ROCKET, PDS
 S-5MO, 57-MM, WARHEAD, HEAT/FRAG, A-TO-S
 S-5MO, MOTOR, 57 MM, SOLID PROPELLENT, A-TO-S

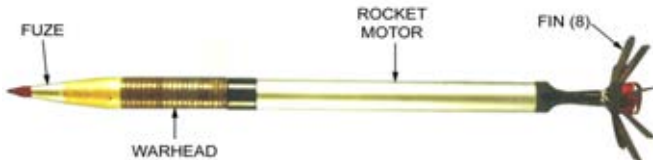

U.S.S.R. ROCKET, 57-MM, HEAT/FRAG, S-5KPB

Ordnance used with:
UB-16-57, UMVP, LAUNCHER, ROCKET, AIRCRAFT
UB-32A1, LAUNCHER, ROCKET, AIRCRAFT (57-MM)
V-5KP1, ROCKET, PIBD, A-TO-S

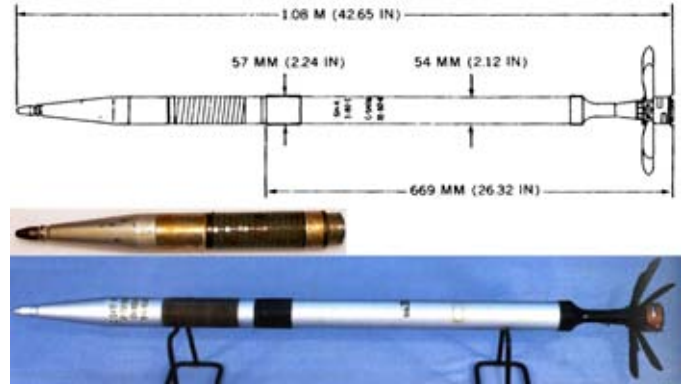

U.S.S.R. ROCKET, 57-MM, ILLUMINATION, S-5-OB

Ordnance used with:
S-5-OB, 57-MM, WARHEAD, ILLUMINATION, A-TO-S
VB-5, ROCKET, NOSE, A-TO-S
S-5-OB, MOTOR, 57-MM, SOLID PROPELLANT, AIR-S...

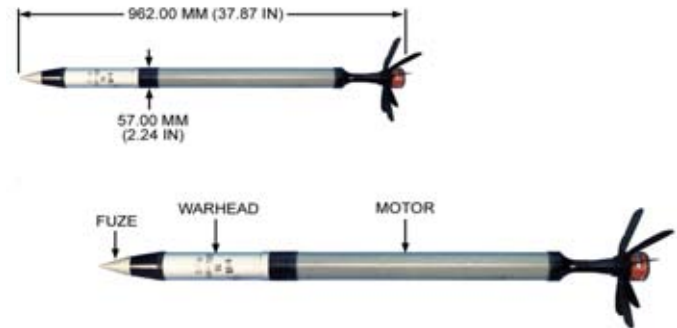

"Image from the Russian Arms Catalog,
Vol. VII, reproduced with permission from
Military Parade Publishing House."

U.S.S.R. ROCKETS, 57-MM, HEAT, S-5K AND S-5K1



Ordnance used with:
UB-16-57-U, 57-MM, LAUNCHER, RKT
V-5K, ROCKET, PD, A-TO-S
MP-4, PROJECTILE, PD
UB-16-57-U, 57 MM, LAUNCHER, ROCKET, 16 SHOT

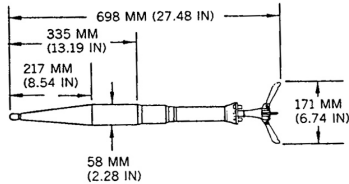

U.S.S.R. GRENADE, 58-MM, ROCKET-PROPELLED, HEAT-FS-T, PG-16

Ordnance used with:
VP-16 G CH, ROCKET, PIBD, PI ELEMENT
PG-16P, 57MM, EXPPELLING CHARGE, RKT
VP-9 D CH, ROCKET, PIBD, BASE DETONATING ELEMENT
PG-16V, 58MM, CARTRIDGE, HEAT



N.E.W. 800.00 G

YUGOSLAV ROCKET, 64-MM, HEAT, M80

Ordnance used with:
RBR M80, 64-MM, RKT SYSTEM, HEAT



U.S. ROCKET WARHEAD, 2.75-IN, HE, M261

Ordnance used with:
LAU-130/A, LAUNCHER, RKT
LAU-131/A, LAUNCHER, RKT
LAU-3/A, LAUNCHER, RKT
LAU-32/A, LAUNCHER, RKT
LAU-32A/A, LAUNCHER, RKT
LAU-3A/A, LAUNCHER, RKT
LAU-3B/A, LAUNCHER, RKT
N.E.W. 34.18 OZ

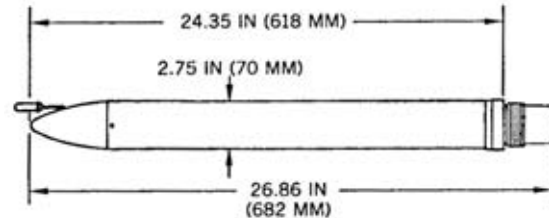

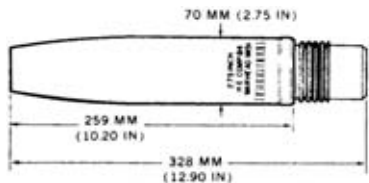

U.S. ROCKET WARHEAD, 2.75-IN, HE-FRAG, M151

Ordnance used with:

LAU-130/A, LAUNCHER, RKT
 LAU-131/A, LAUNCHER, RKT
 LAU-3/A, LAUNCHER, RKT
 LAU-32/A, LAUNCHER, RKT
 LAU-32A/A, LAUNCHER, RKT
 LAU-3A/A, LAUNCHER, RKT
 LAU-3B/A, LAUNCHER, RKT

N.E.W. 1.00 KG

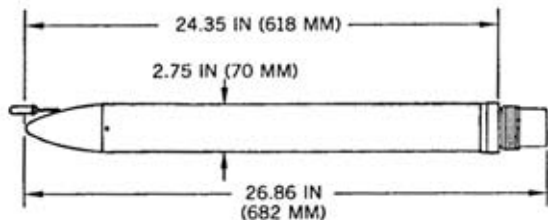

U.S. ROCKET WARHEAD, FLECHETTE, 2.75-IN, HE, M255A1

Ordnance used with:

LAU-130/A, LAUNCHER, RKT
 LAU-131/A, LAUNCHER, RKT
 LAU-3/A, LAUNCHER, RKT
 LAU-32/A, LAUNCHER, RKT
 LAU-32A/A, LAUNCHER, RKT
 LAU-3A/A, LAUNCHER, RKT
 LAU-3B/A, LAUNCHER, RKT

U.S.S.R. ROCKET, 70-MM, HEAT, PG-7M

Ordnance used with:
VP-7M, ROCKET, PIBD
PG-7VM, 70MM, CARTRIDGE, HEAT
PG-7VM, 70MM, CARTRIDGE, HEAT

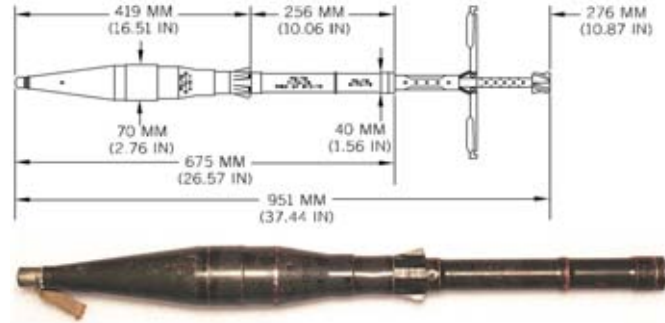

N.E.W. 489.00 G

U.S.S.R. ROCKET, 70-MM, GROUND-TO-GROUND, HEAT, PG-7S

Ordnance used with:
PG-7P, EJECTION CHARGE FOR PG-7-SERIES ROCKETS
VP-7M G CH, FUZE, ROCKET, PI ELEMENT
VP-7M D CH, FUZE, ROCKET, BASE DETONATING ELEMENT



BULGARIAN CARTRIDGE, 73-MM, ROCKET, PRACTICE, PG-15



Ordnance used with:
MDL. UNKNOWN, PG-9, 73MM, RKT MOTOR
PG-9, 73MM, PRACTICE
PG-15P, 73MM, PROPELLING CHARGE
PG-9, WARHEAD, 73-MM, PRAC



BULGARIAN ROCKET, 73-MM, HEAT, PG-9



Ordnance used with:
PG-15V, CARTRIDGE, 73MM, HEAT
VP-9 G CH, ROCKET, PI ELEMENT
PG-9V, 73MM, CARTRIDGE, ROCKET, HEAT
MDL. UNKNOWN, PG-9, 73MM, RKT MOTOR
346 E, 73MM, PROPELLING CHARGE
PG-9P, 73MM, EXPELLING CHARGE
PG-9P, 73MM, PROPELLING CHARGE

BULGARIAN WARHEAD, 73-MM, ROCKET, HEAT, PG-9N

Ordnance used with:

PG-15VN, CARTRIDGE, 73MM, HEAT

PG-9N, 73MM, HEAT

VP-9 G CH, ROCKET, PI ELEMENT

MDL. UNKNOWN, PG-9, 73MM, RKT MOTOR

PG-9VN, 73MM, CARTRIDGE, ROCKET, HEAT

346 E, 73MM, PROPELLING CHARGE

PG-9P, 73MM, EXPELLING CHARGE



BULGARIAN WARHEAD, 73MM, ROCKET, HEAT, PG-9

Ordnance used with:

PG-15V, CARTRIDGE, 73MM, HEAT

PG-9, 73MM, HEAT

VP-9 G CH, ROCKET, PI ELEMENT

PG-9V, 73MM, CARTRIDGE, ROCKET, HEAT

MDL. UNKNOWN, PG-9, 73MM, RKT MOTOR

VP-9 D CH, ROCKET, BD ELEMENT



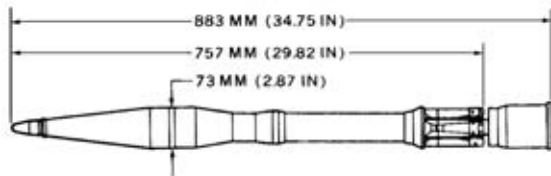

U.S.S.R. CARTRIDGE, 73-MM, HEAT-T, PG-9, PG-9S & PG-9 PRACTICE

Ordnance used with:
 PG-15, CARTRIDGE, 73-MM, HEAT-T
 VP-9, ROCKET, PIBD



N.E.W. 335.00 G



BULGARIAN ROCKET MOTOR, 73-MM, PG-9

Ordnance used with:
 PG-15V, CARTRIDGE, 73MM, HEAT
 PG-9, 73MM, HEAT
 PG-15VN, CARTRIDGE, 73MM, HEAT
 PG-9N, 73MM, HEAT
 PG-9V, 73MM, CARTRIDGE, ROCKET, HEAT
 PG-9VN, 73MM, CARTRIDGE, ROCKET, HEAT
 346 E, 73MM, PROPELLING CHARGE



N.E.W. 495.00 G

CHINESE ROCKET, 75-MM, APERS, BOUNDING, TYPE 69

Ordnance used with:
MJ-7, FUZE, ROCKET, PI
DREOI, FUZE, ROCKET, PI

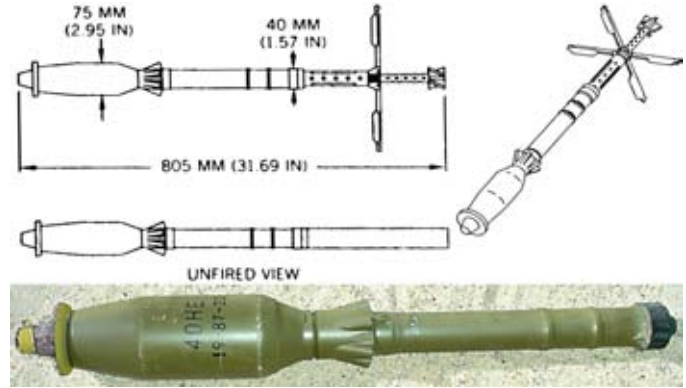

U.S.S.R. ROCKET MOTOR, 80-MM, SOLID PROPELLANT, S-8-OF

Ordnance used with:
S-8-OF, 80-MM, HE/FRAG, A-TO-S
V-8, ROCKET, PD, A-TO-S
S-8-OF, WARHEAD, 80-MM, HE/FRAG, A-TO-S

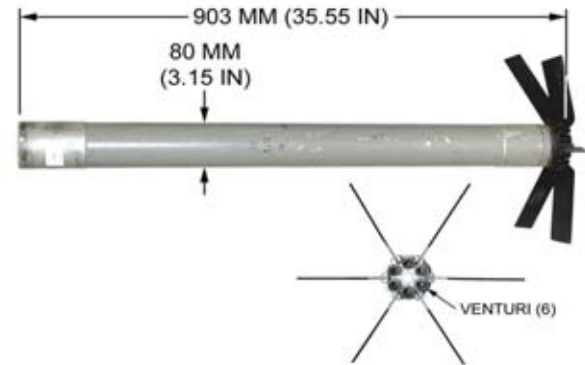

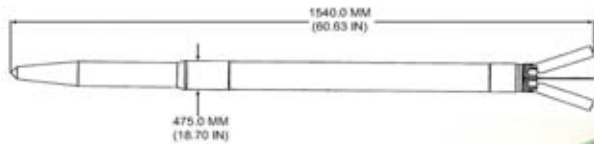

U.S.S.R. ROCKET, 80-MM, APHE, S8BM



U.S.S.R. ROCKET, 80-MM, CHAFF, S8PM

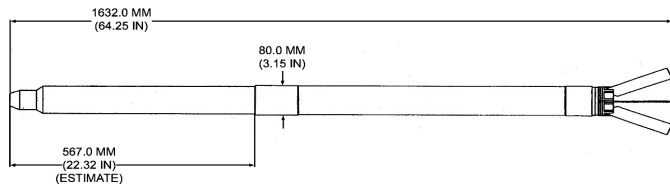

U.S.S.R. ROCKET, 80-MM, FAE, S8DM

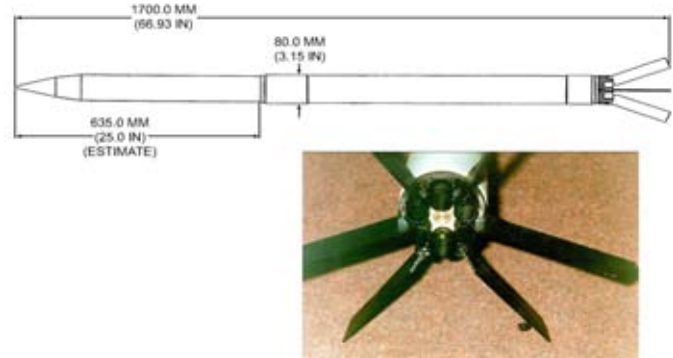

U.S.S.R. ROCKET, 80-MM, FLECHETTE, S8ASM

Ordnance used with:

- B-8M, LAUNCHER, ROCKET, 20-SHOT
- B-8M1, LAUNCHER, ROCKET, 20-SHOT
- B-8V20-A, LAUNCHER, ROCKET, 20-SHOT
- B-8V20A, LAUNCHER, ROCKET, 20-SHOT
- B-8V7, LAUNCHER, 7-SHOT

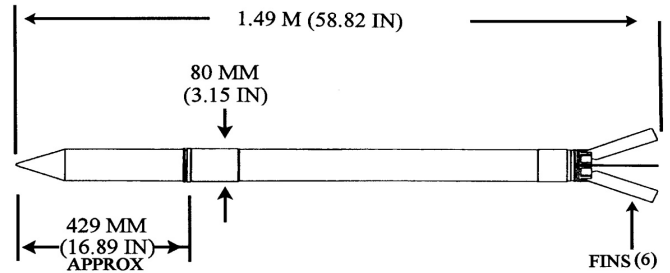

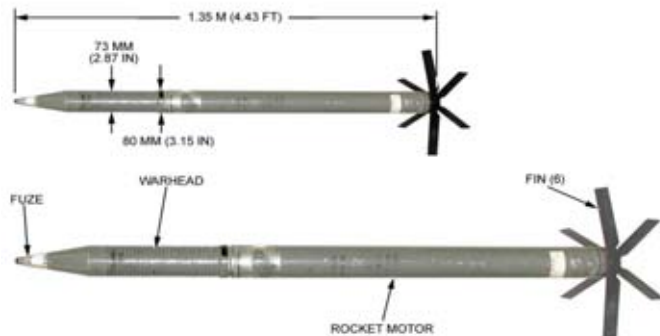

U.S.S.R. ROCKET, 80-MM, HE/FRAG, S-8-OF

Ordnance used with:
 V-8, ROCKET, PD, A-TO-S
 S-8-OF, WARHEAD, 80-MM, HE/FRAG, A-TO-S
 S-8-OF, 80-MM, MOTOR, SOLID PROPELLANT, A-TO-S

N.E.W. 10.04 KG

U.S.S.R. ROCKET, 80-MM, ILLUMINATION, S80M

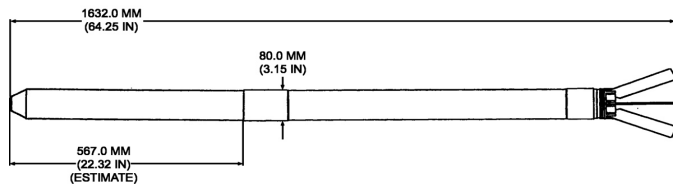

U.S.S.R. WARHEAD, 80-MM, HE/FRAG, S-8-OF

Ordnance used with:
S-8-OF, 80-MM, HE/FRAG, A-TO-S
V-8, ROCKET, PD, A-TO-S
S-8-OF, 80-MM, MOTOR, SOLID PROPELLANT, A-TO-S



N.E.W. 1.37 KG

YUGOSLAV ROCKET SYSTEM, 64-MM, HEAT, RBR M80

Ordnance used with:
M80, 64MM, HEAT

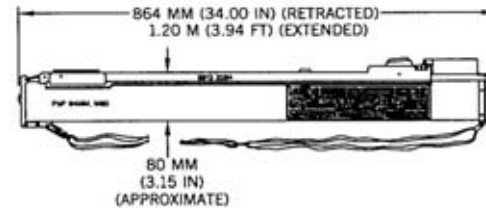

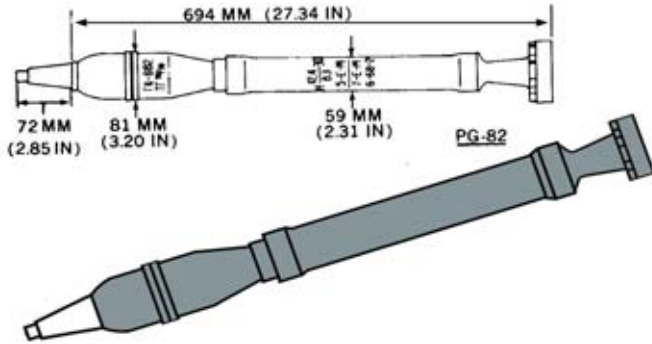

U.S.S.R. ROCKET, 82 MM, HE, OG82

Ordnance used with:
 GK-1, FUZE, PROJECTILE, PD
 GK-2, FUZE, PROJECTILE, PD
 GK-2M, FUZE, PROJECTILE, PD
 GK-662, 82 MM, WARHEAD, HEAT



U.S.S.R. ROCKET, 80-MM, HEAT/FRAG, S-8KO

Ordnance used with:
 9-K1-608, ROCKET, BASE ELEMENT, A-TO-S
 B-8M, LAUNCHER, ROCKET, 20-SHOT
 B-8M1, LAUNCHER, ROCKET, 20-SHOT
 B-8V20-A, LAUNCHER, ROCKET, 20-SHOT
 B-8V20A, LAUNCHER, ROCKET, 20-SHOT
 B-8V7, LAUNCHER, 7-SHOT
 V-5KP1, ROCKET, PIBD, A-TO-S
 N.E.W. 1.00 KG



U.S.S.R. ROCKET, 80-MM, HEAT/FRAG, S-8KOM

Ordnance used with:

9-K1-608, ROCKET, BASE ELEMENT, A-TO-S
B-8M, LAUNCHER, ROCKET, 20-SHOT
B-8M1, LAUNCHER, ROCKET, 20-SHOT
B-8V20-A, LAUNCHER, ROCKET, 20-SHOT
B-8V20A, LAUNCHER, ROCKET, 20-SHOT
B-8V7, LAUNCHER, 7-SHOT
V-5KP1, ROCKET, PIBD, A-TO-S

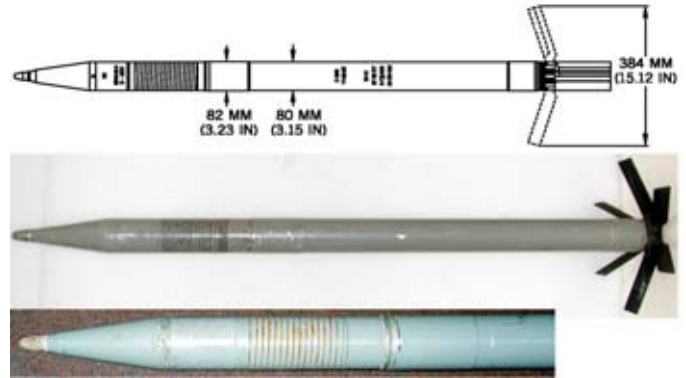

BULGARIAN ROCKET, 85-MM, HEAT, PG7

Ordnance used with:

VP-7M, ROCKET, PIBD
PG-7P, EJECTION CHARGE FOR PG-7-SERIES ROCKETS
VP-7M D CH, FUZE, ROCKET, BASE DETONATING ELEMENT
VP-7M G CH, FUZE, ROCKET, PI ELEMENT
PG-7, RKT MOTOR

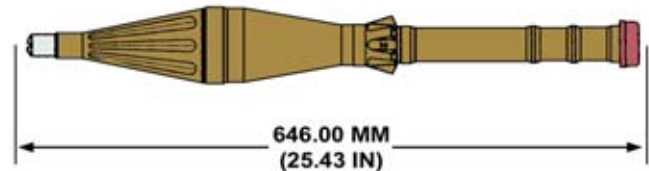

N.E.W. 603.44 G



CHINESE ROCKET, 85-MM, HEAT, TYPE 69-1

Ordnance used with:
MDL. UNKNOWN, EXPPELLING CHARGE FOR TYPE 69-1
FUZE, WARHEAD, PIBD, TYPE 69-1



IRANIAN ROCKET, HEAT-T, NADER

PAKISTANI ROCKET, 85MM, HEAT, P1 MK1



U.S.S.R. ROCKET, 85-MM, HEAT, PG-7

Ordnance used with:
VP-7, ROCKET, PIBD
PG-7P, EJECTION CHARGE FOR PG-7-SERIES ROCKETS





U.S.S.R. ROCKET, 85-MM, HEAT-T, MODEL PG-7G

Ordnance used with:
UNDESIGNATED, GRENADE, PIBD

N.E.W. 770.00 G

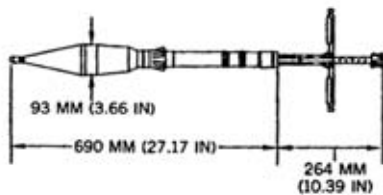

U.S.S.R. GRENADE, 93-MM, HEAT-T, ROCKET PROPELLED, PG-7VL

Ordnance used with:
PG-7L, 94MM, HEAT
PG-7P, EXPPELLING CHARGE



CHINESE ROCKET, 107-MM, HE, TYPE 63-2

Ordnance used with:
MJ-1, ROCKET, PD

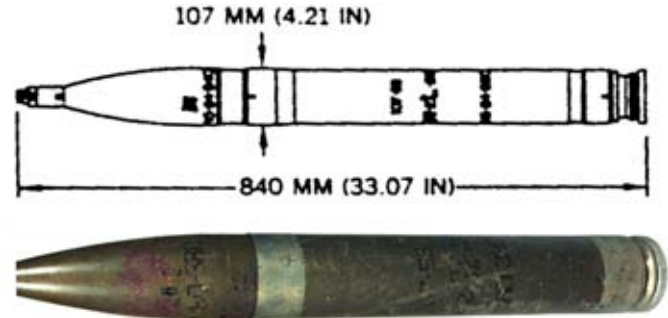

N.E.W. 1.30 KG

CHINESE ROCKET, 107-MM, HE-FRAG, SPIN-STABILIZED, TYPE 63

Ordnance used with:
MD-21, ROCKET, PROX.
TYPE 1, ROCKET, PD

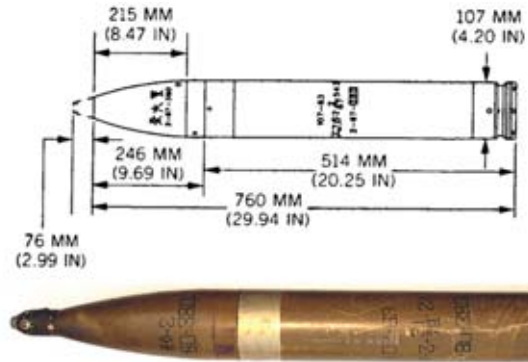

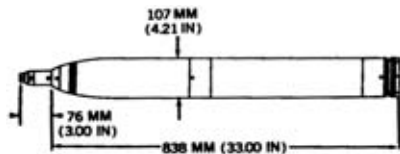

CHINESE ROCKET, 107-MM, INCENDIARY, TYPE 63-1

Ordnance used with:
MD-21, ROCKET, PROX.
MJ-1, ROCKET, PD
TYPE 63-1, WARHEAD, 107 MM, INCENDIARY

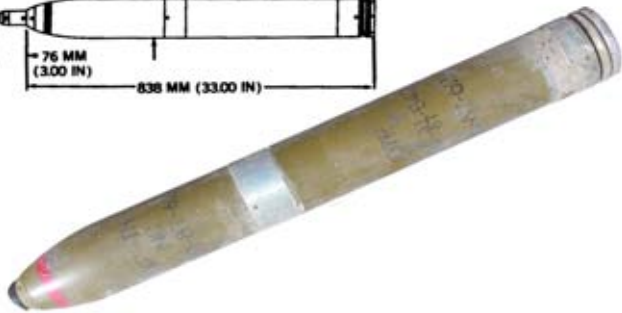

NORTH KOREAN ROCKET, 107MM, HE, R107

Ordnance used with:
TYPE 107, ROCKET, PD
MDL. UNKNOWN, ROCKET, FOR R107



**U.S.S.R. ROCKET, 122-MM, AIR-TO-SURFACE, HE,
S-13D**

Ordnance used with:
B-13L, LAUNCHER, ROCKET, 5 SHOT

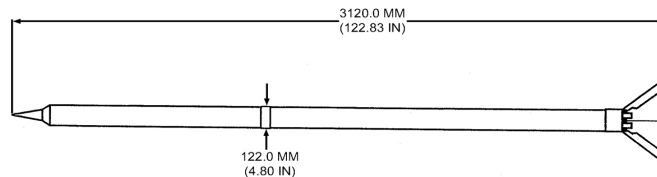

U.S.S.R. ROCKET, 122-MM, HE, 9M28F

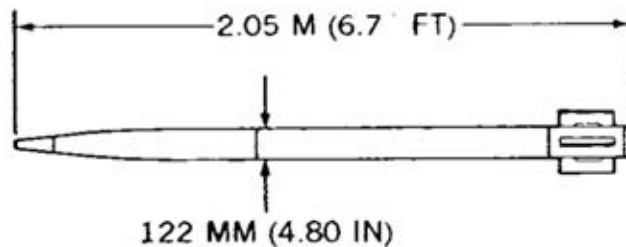

N.E.W. 6.00 KG

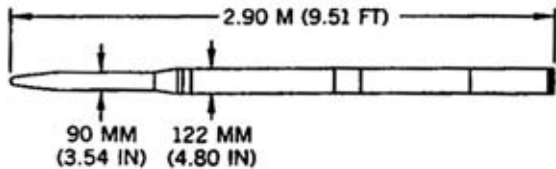

U.S.S.R. ROCKET, 122-MM, HE, S-13

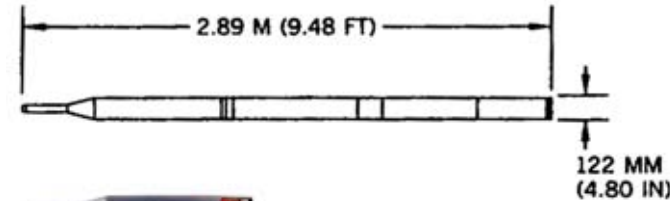

U.S.S.R. ROCKET, 122-MM, HE, S-13-OF

Ordnance used with:
B-13L, LAUNCHER, ROCKET, 5 SHOT



N.E.W. 7.00 KG

U.S.S.R. ROCKET, 122-MM, HE, S-13-T

Ordnance used with:
B-13L, LAUNCHER, ROCKET, 5 SHOT

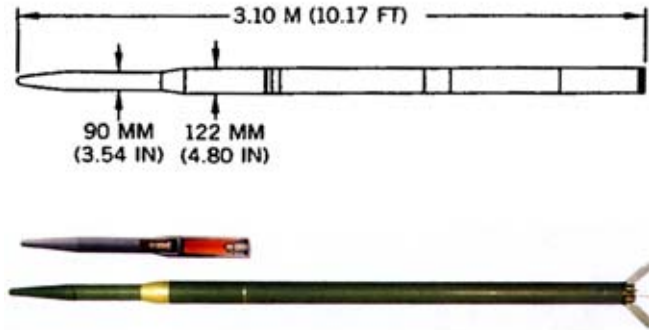

N.E.W. 4.50 KG

U.S.S.R. ROCKET, 122-MM, HE-FRAG, FIN & SPIN-STABILIZED, 9M22U (9-FOOT)

Ordnance used with:
MRV-U, ROCKET, PD
9E210, ROCKET, PD
M-210F, WARHEAD, 122-MM, HE-FRAG
M-210FM, RKT WARHEAD, 122-MM, HE-FRAG
MRV-U, ROCKET, PD

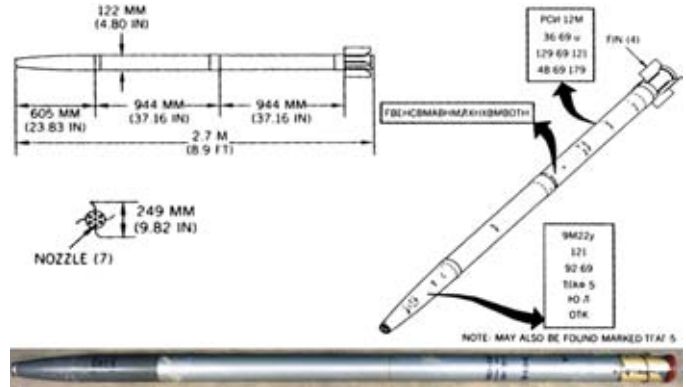



U.S.S.R. ROCKET, 122-MM, HE-FRAG, FIN- & SPIN-STABILIZED, 9M22M (6-FOOT)

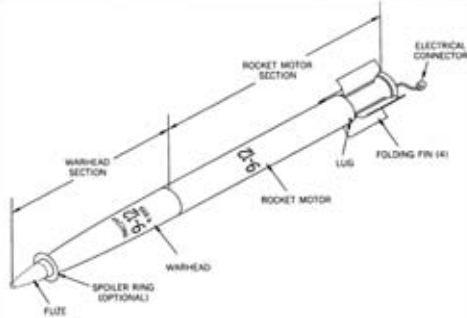

Ordnance used with:
DKZ-B, ROCKET, NOSE, PD
MRV, RKT FUZE, PD
MRV-42M, ROCKET, PD
MRV-U, ROCKET, PD
M-210F, WARHEAD, 122-MM, HE-FRAG
M-210FM, RKT WARHEAD, 122-MM, HE-FRAG
MRV-U, ROCKET, PD

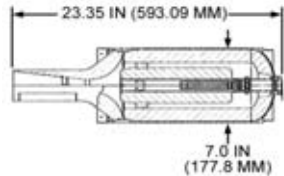

U.S. GUIDED MISSILE ROCKET MOTOR, M120E4



Ordnance used with:
AGM-114K, GUIDED MISSILE, A-TO-S (HELLFIRE II)
AGM-114L, GUIDED MISSILE, A-TO-S (LONGBOW)
AGM-114M, GUIDED MISSILE, AIR-TO-SURFACE, HEL...
AGM-114N, GUIDED MISSILE, HELLFIRE II

N.E.W. 21.96 LB

U.S.S.R. ROCKET, 64-MM, HEAT, MODEL PG-18

Ordnance used with:
V659, ROCKET, BD
VP-18 D CH, ROCKET, BD ELEMENT

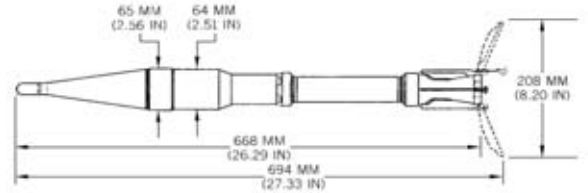

U.S.S.R. ROCKET WARHEAD, 220-MM, AT, MINE DISPENSING, 9N128K2

Ordnance used with:
9M27K2, 220 MM, CARGO
PGMDM, LANDMINE, AT
PTM-1, LANDMINE, AT
PTM-1S, LANDMINE, AT



"Image from Russian Arms Catalog,
Vol. 7, reproduced with Permission from
Military Parade Publishing House."

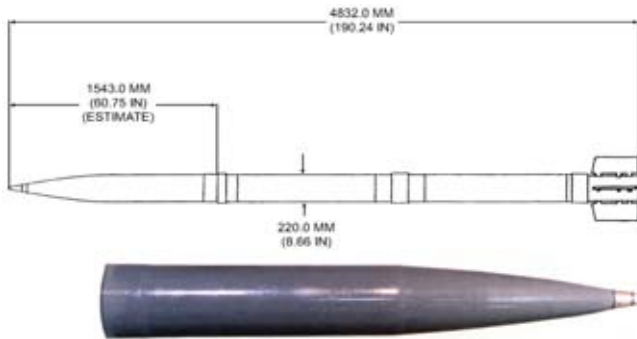

"Image from Russian Arms Catalog,
Vol. 7, reproduced with Permission from
Military Parade Publishing House."

U.S.S.R. ROCKET WARHEAD, 220-MM, HE, 9N128F

Ordnance used with:
MRV-U, ROCKET, PD
9M27F, 220MM, HE
MRV-U, ROCKET, PD

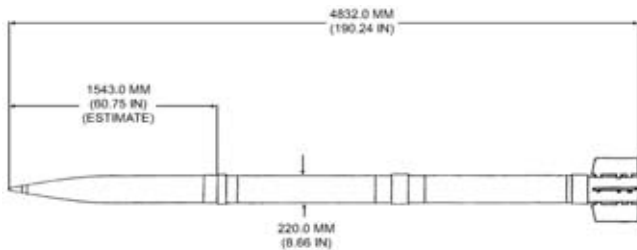

U.S.S.R. ROCKET, 220-MM, HE, 9M27F

Ordnance used with:
MRV-U, ROCKET, PD
9N128F, WARHEAD, 220MM, HE
MRV-U, ROCKET, PD



U.S.S.R. ROCKET, 220-MM, HE, 9M27K1

Ordnance used with:
9N128K1, WARHEAD, 220MM, CARGO

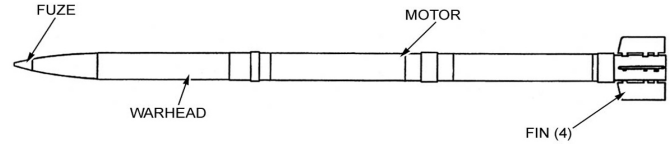

U.S.S.R. ROCKET, SURFACE-TO-SURFACE, 220-MM, AT, MINE DISPENSING, 9M27K2

Ordnance used with:
PGMDM, LANDMINE, AT
PTM-1, LANDMINE, AT
PTM-1S, LANDMINE, AT
9N128K2, WARHEAD, 220MM, CARGO

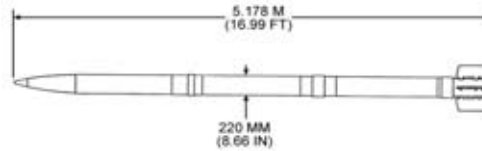

U.S.S.R. ROCKET, SURFACE-TO-SURFACE, APERS, MINE DISPENSING, 9M27K3

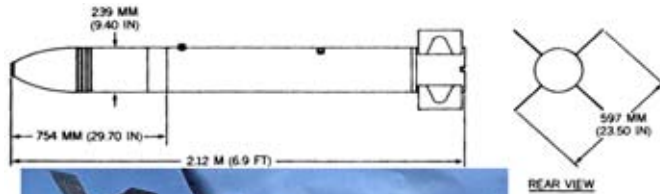
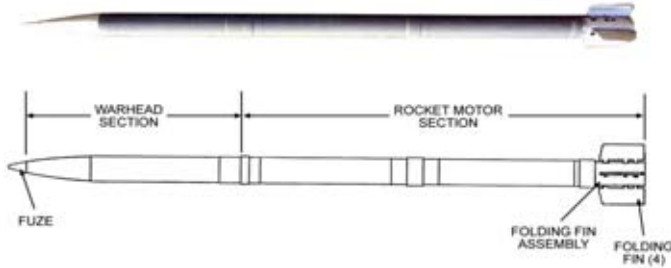

U.S.S.R. ROCKET, 240-MM, AIRCRAFT, HE, MODEL S-24

Ordnance used with:
V-24A, PD, RKT
9-A-682, ROCKET, PROXIMITY, A-TO-S
RV-24, ROCKET, PROXIMITY, A-TO-S



BULGARIAN PROPELLING CHARGE, 73-MM, PG-9P

Ordnance used with:

PG-9, 73MM, HEAT

PG-9N, 73MM, HEAT

346-E, 73MM, CARTRIDGE, HE (TEARDROP)

346E, 73MM, CARTRIDGE, HE (TEARDROP)

OG-9, 73MM, CARTRIDGE, HE (TEARDROP)

OG-9/F, 73MM, CARTRIDGE, HE (TEARDROP)

PG-9V, 73MM, CARTRIDGE, ROCKET, HEAT

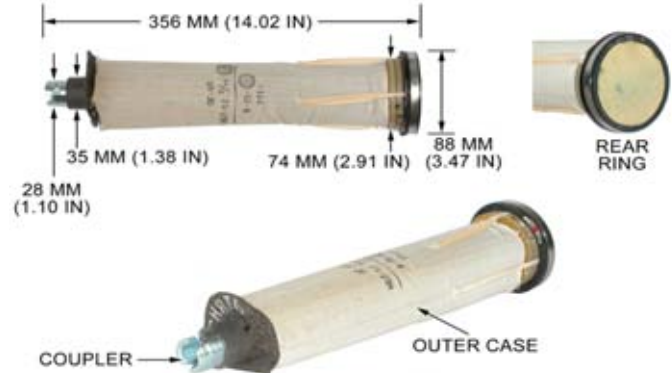

THIS PAGE INTENTIONALLY LEFT BLANK